

MOVING WINE STORAGE FORWARD

RESOURCE GUIDE



VINTAGEVIEW®

MOVING WINE STORAGE FORWARD

W SERIES

We developed our hallmark W Series line with designers in mind. It started the label-forward wine storage movement in 2001 bringing modern sophistication to the industry.

Our patented wine rack puts the label on display, creating artful collections perfect for any room – residential or commercial – and any sized collection.



How it Works

Included Hardware

A. End Caps

B. M4 Toggle Bolts
(for drywall installs only)

C. #8 Wood Screws
(Directly into wood surfaces
or drywall anchors)

D. Mounting Hole Covers

E. Zinc spiral inserts
(for drywall installs only)

F. Couplers

(for connecting two W Series
columns vertically)

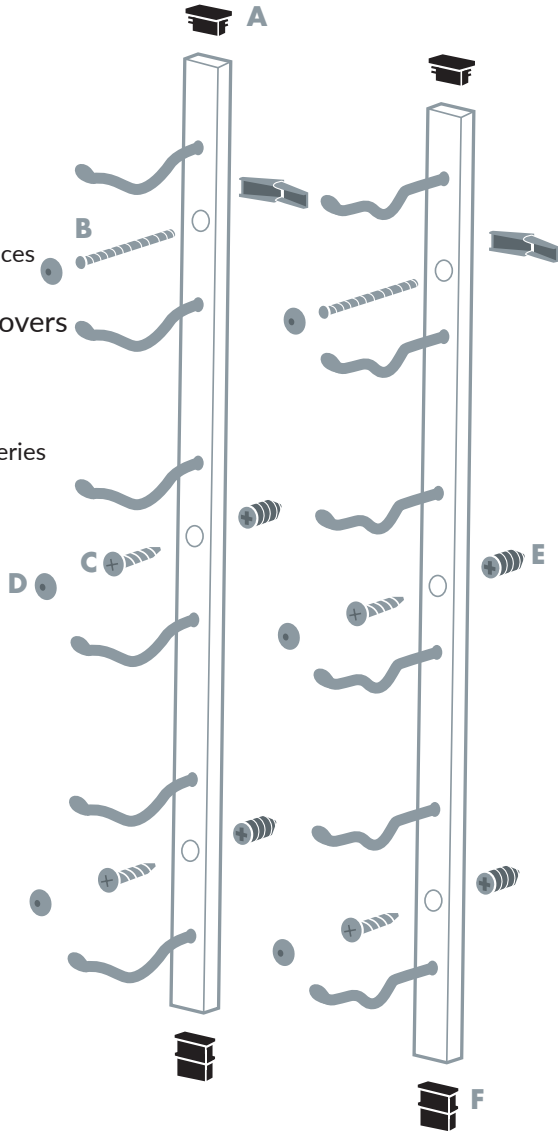

Installation
Centerline

Standard/Champagne: 7½"
Magnum: 8½"
Larger formats: 10"-14" formats

W SERIES

Specs



Single

h: 5"
w: 13"
d: 5¼"
capacity: 1



Minimal

(single-bottle depth)
h: 4.5", 1', 2', 3', 4'
w: 13"
d: 5¼"
capacity: 1-12



Balanced

(double-bottle depth)
h: 4.5", 1', 2', 3', 4'
w: 13"
d: 8½"
capacity: 2-24

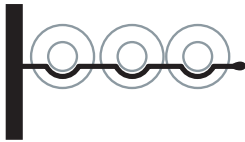

Maximum

(triple-bottle depth)
h: 14.5", 1', 2', 3', 4'
w: 13"
d: 12"
capacity: 3-36



Magnum Minimal

(single-bottle depth)
h: 45"
w: 15"
d: 5¼"
capacity: 9

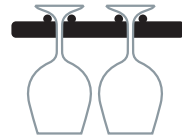

Stemware Racks

h: 4"
w: 13"
d: 6½" | 9.5" | 13"
glasses: 2 | 4 | 6



Magnum Balanced

(double-bottle depth)
h: 45"
w: 15"
d: 10"
capacity: 18



Big Bottle ≤6L

(single-bottle depth)
h: 45"
w: 18"+
d: 8"
capacity: 4 (3L-6L)

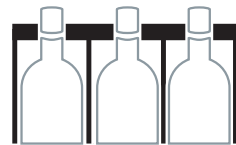

Presentation Rows

h: 6"
w: 13" | 39"
d: 13"
capacity: 3 | 9

Finishes



Brushed Nickel
(-P)



Chrome Luxe
(-CL)



Matte Black
(-K)

Ask about custom powder coating!

W SERIES

Accessories



Stemware Rack



Single



Bottle Retention Strap



Presentation Row



Perch

Ordering/Skus

This is the product collection:

WS-W Series

E1/WW-Evolution Series

V-Vino Series

FCF-Floor to Ceiling Frames

IDR-Island Display Racks

GNR-Grain + Rod

CC-Case & Crate

WS12-X

Height and Depth:

Ex: 1-one foot/
2-double bottle

Finish:

K-Matte Black

CL-Chrome Luxe

P-Brushed Nickel



W SERIES FRAMES

W Series Frames create floating wine walls in homes and restaurants, allowing designers to create unique, stylish room dividers.

Simply, these Frames are the utility tool that takes the W Series off the wall, allowing for installation even when wall-mounting space is at a premium.



How it works



The frame can be cut on site to fit your ceiling height.

*10' includes 2 sections
12' includes 3 sections*

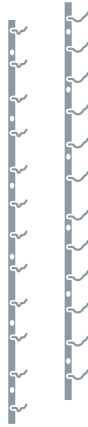

Add W Series racking to one or both sides.

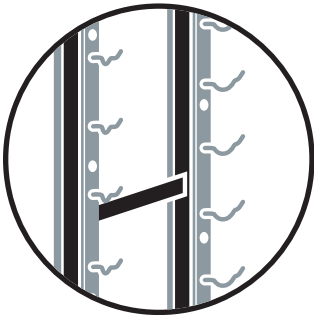
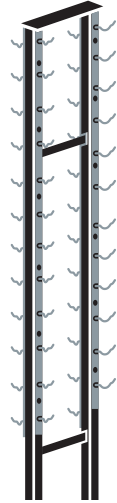

Add a backer bar to one-sided displays.

Available in 15-foot solid sections (lead times apply)

Hardware

Self-drilling metal screws included to mount W Series products (racking sold separately).

Mounting hardware for floor or ceiling not included.

Installation
Centerline

Standard/Champagne: 13"
Magnum: 15"

W SERIES FRAMES

Specs

FCF Split

Height	Width	Depth
120 in	Custom	Varies*

FCF HD

Height	Width	Depth
120 in	13 in	Varies*

FCF-C12

Height	Width	Depth
144 in	13 in	Varies*

FCF Mag

Height	Width	Depth
120 in	15 in	Varies*

FCF Big Bottle

Height	Width	Depth
120 in	Custom	Varies*

*Depth (Standard)

Single-Sided Display Depth:

Single: 6¾"

Double: 10"

Triple: 13½"

Double-Sided Display Depth:

Single, Single: 11½"

Single, Double: 14¾"

Single, Triple: 18¼"

Double, Double: 18"***

Double, Triple: 21½"***

Triple, Triple: 25"***

(Magnum)

Single-Sided Display Depth:

Single: 6¾"

Double: 11½"

Double-Sided Display Depth:

Single, Single: 11½"***

Single, Double: 16¼"

Double, Double: 21"***

(Big Bottle)

Single-Sided Display Depth:

Single: 9½"

Double-Sided Display Depth:

Single: 17"

** These configurations cannot be label forward against glass without room to pull bottles from the side.

Finishes



Brushed Nickel
(-P)



Chrome
(-CH)



Matte Black
(-K)

W SERIES FRAMES

Accessories



Floor-to-Wall Bracket



Hidden Base Plate



Extension Bracket



Elbow Bracket



Angled Base Plate



Base Plate (for sections less than 5 feet in height)



Perch

Ordering/Skus

This is the product collection:

WS-W Series

E1/WW-Evolution Series

V-Vino Series

FCF-Floor to Ceiling Frames

IDR-Island Display Racks

GNR-Grain + Rod

CC-Case & Crate

FCF-HD-P

Height:

HD-10-foot standard frame

12-12-foot kit

C12-Custom 12-foot solid
frame

Finish:

K-Matte Black

P-Brushed Nickel

CH-Chrome



VINO SERIES

The Vino Series peg system brings a new edge to minimalism in the wine cellar. Starting at just one bottle, the label-forward Pins and cork-forward Rails allow designers to break from linear wine racking and create eye-catching focal points in any room.

Plus, this is the only peg system that can mount directly into any surface, including drywall.



How it works

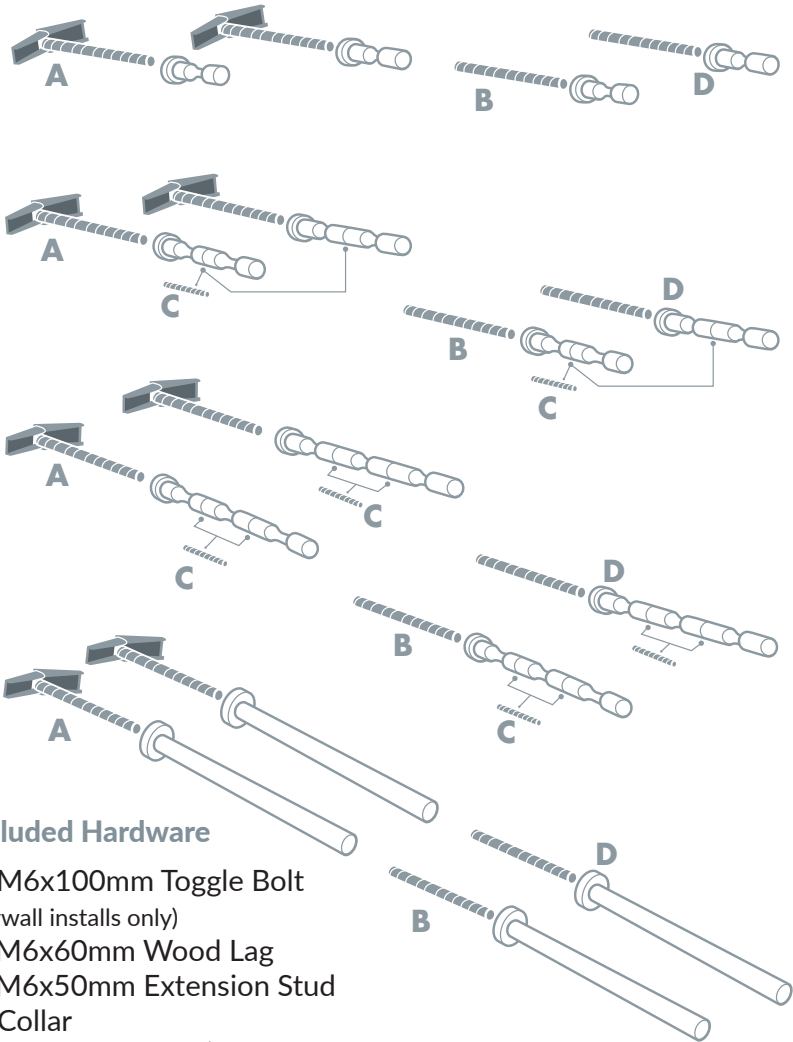

Included Hardware

- A. M6x100mm Toggle Bolt
(drywall installs only)
- B. M6x60mm Wood Lag
- C. M6x50mm Extension Stud
- D. Collar
(for drywall installs only)

Installation
Centerline

Pins Standard/Champagne: 7½"
Pins Magnum: 8½"
Rails: 2½" (2" for stemware storage)

VINO SERIES

Specs



Minimal

Standard or Mag bottles
(single-bottle depth)

h: 5"

w: 13" standard/

15" mag

d: 4"*

capacity: 1



Balanced

(double-bottle depth)

h: 5"

w: 13"

d: 8"*

capacity: 2



Maximum

(triple-bottle depth)

h: 5"

w: 13"

d: 12"*

capacity: 3



Magnum Balanced

(double-bottle depth)

h: 5"

w: 15"

d: 8½*

capacity: 2 (1.5L)



Standard Bottle

(single-bottle depth)

h: 5"

w: 3"

d: 13"*

capacity: 1



Magnum Bottle

(single-bottle depth)

h: 5"

w: 3"

d: 15"*

capacity: 1

* Collars add 1/2" to the depth
(required for drywall installs)

Finishes



Clear Acrylic*
(-A)

*single deep
pins only



Milled Aluminum



Gloss Black
(-GK)



Matte Black, Gunmetal
and Golden Bronze
available

VINO SERIES

New Finishes



Matte Black (-K)



Gunmetal (-GM)



Golden Bronze (-GB)

VINO SERIES

Accessories



Collars

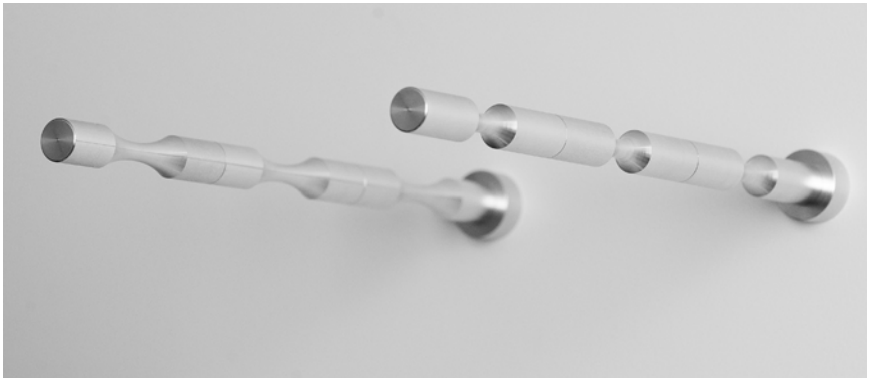

Extension Pieces
(up to three total bottles deep)



Masonry hardware



Magnum spacers

VINO SERIES

The **Vino Series Post** provides the ability to take the rack off the wall to create beautiful floor-to-ceiling displays in front of glass, in the middle of rooms, or anywhere else where wall access is at a premium.



Ordering/Skus

This is the product collection:

WS-W Series

E1/WW-Evolution Series

VP-Vino Pins

VR-Vino Rails

FCF-Floor to Ceiling Frames

IDR-Island Display Racks

GNR-Grain + Rod

CC-Case & Crate

C-Denotes the product includes collars

VPC-MAG3-K

Bottle Type:
MAG-Magnum or
 Champagne
*No notation for
 standard bottle*

Kit Depth:
 2-Double
 3-Triple
*No notation for base unit
 only*

Finish:
K-Matte Black
A-Clear Acrylic
*No notation for
 milled aluminum
 only*



CASE & CRATE



With design and expandability in mind, the Case & Crate collection brings style to bulk wine storage.

The lockers and bins in this lineup can store bottles by the case load and integrate perfectly with label-forward wine racking displays.

CASE & CRATE

How it Works

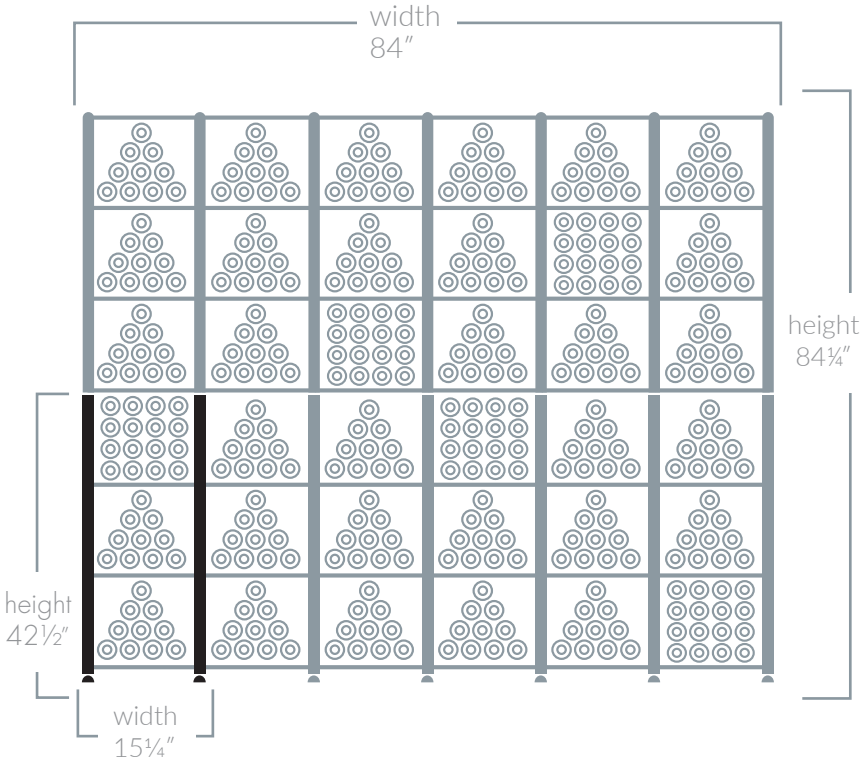

Start with a base unit, stack one on top, and expand to the side as many times as you need with Extension Units!

Specs

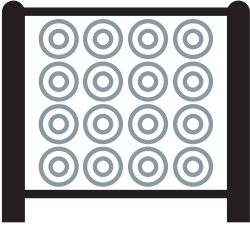

Bin

h: 42½" | 3 cubes
 w: 15¼"
 d: 15"
 capacity: 48

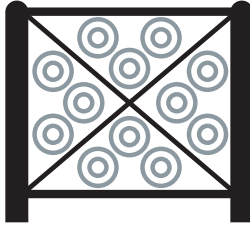

Bin with X-bins

(optional accessory)
 h: 42½" | 3 cubes
 w: 15¼"
 d: 15"
 capacity: 36

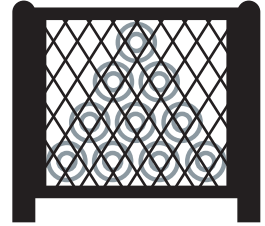

Locker

h: 42½" | 3 cubes
 w: 15¼"
 d: 15"
 capacity: 48

Add 41¾" when stacking

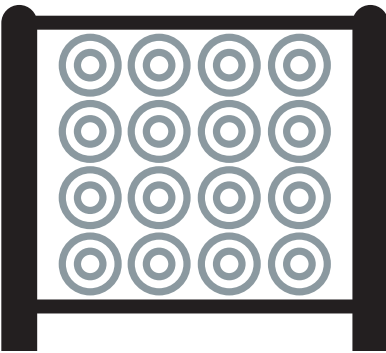

Included Hardware

Metal screws
 Wall bracket
 M4 toggle bolt
 Adjustable footers

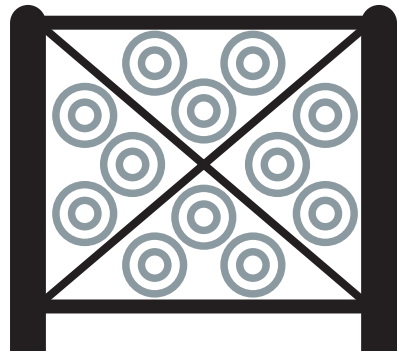

Bin with X-bin

Reduces count by 4 bottles per cube

CASE & CRATE

Finish



Matte Black
(-K)

Accessories



CC-Shelf
Syrah Shelf



CC-Back
Back Insert



CC-Xbin
X-Bin Insert



CC-Door
Locker Doors



CC-Lock
Locks



CC-Label
Two Styles

Ordering/Skus

This is the product collection:

WS-W Series

E1/WW-Evolution Series

V-Vino Series

FCF-Floor to Ceiling Frames

IDR-Island Display Racks

GNR-Grain + Rod

CC-Case & Crate 2.0

Finish:

K-Matte Black

CC2-LOCKER-T3-K

Style:

BIN-Bin

LOCKER-Locker

Size:

S-Short

T-Tall

Kits:

2-Extension + Base

3-Two Extensions + Base

4-Three Extensions + Base



IDR SERIES

We make retail stylish. The Island Display Rack takes the best of our label-forward design, building it into great looking, freestanding wine displays. Customers will love how easy it is to shop their favorite labels.



How it Works

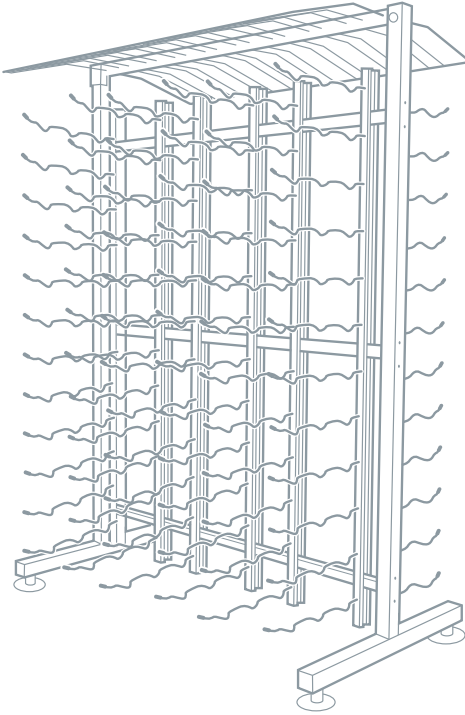

Included Hardware
Everything
you need to
assemble!

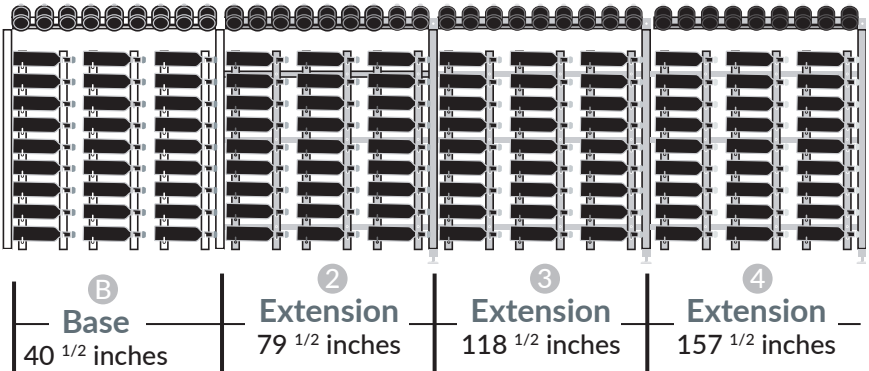

Share an upright! Start with a base unit, and expand to the side as many times as you need with Extension Units!

IDR SERIES

Specs

IDR 3 Kits

	Height	Width	Depth	Columns	Bottles
B	44 ^{3/4} in	40 ^{1/2} in	26 ^{3/4} in	3	180
2	44 ^{3/4} in	79 ^{1/2} in	26 ^{3/4} in	6	360
3	44 ^{3/4} in	118 ^{1/2} in	26 ^{3/4} in	9	540
4	44 ^{3/4} in	157 ^{1/2} in	26 ^{3/4} in	12	720

IDR 4 Kits

	Height	Width	Depth	Columns	Bottles
B	56 in	40 ^{1/2} in	26 ^{3/4} in	3	234
2	56 in	79 ^{1/2} in	26 ^{3/4} in	6	468
3	56 in	118 ^{1/2} in	26 ^{3/4} in	9	702
4	56 in	157 ^{1/2} in	26 ^{3/4} in	12	936

IDR 7 Kits

	Height	Width	Depth	Columns	Bottles
B	86 ^{3/4} in	40 ^{1/2} in	26 ^{3/4} in	3	288
2	86 ^{3/4} in	79 ^{1/2} in	26 ^{3/4} in	6	576
3	86 ^{3/4} in	118 ^{1/2} in	26 ^{3/4} in	9	864
4	86 ^{3/4} in	157 ^{1/2} in	26 ^{3/4} in	12	1152

IDR 73 Kits

	Height	Width	Depth	Columns	Bottles
B	87 ^{1/4} in	40 ^{1/2} in	24 ^{1/2} in	3	378
2	87 ^{1/4} in	79 ^{1/2} in	24 ^{1/2} in	6	756
3	87 ^{1/4} in	118 ^{1/2} in	24 ^{1/2} in	9	1134
4	87 ^{1/4} in	157 ^{1/2} in	24 ^{1/2} in	12	1512

Finishes



Brushed Nickel
(-P)



Matte Black
(-K)

IDR SERIES

Accessories



Casters



Shelf Brackets



Price Tag holders



Point of Purchase



End Cap

Ordering/Skus

This is the product collection:

WS-W Series

E1/WW- Evolution Series

V-Vino Series

FCF-Floor to Ceiling Frames

IDR-Island Display Racks

GNR-Grain + Rod

CC-Case & Crate

Finish:

K-Matte Black

P-Brushed Nickel

IDR3-K



Size:

Denotes height of WS racking (in feet) used. This is not the overall unit height.

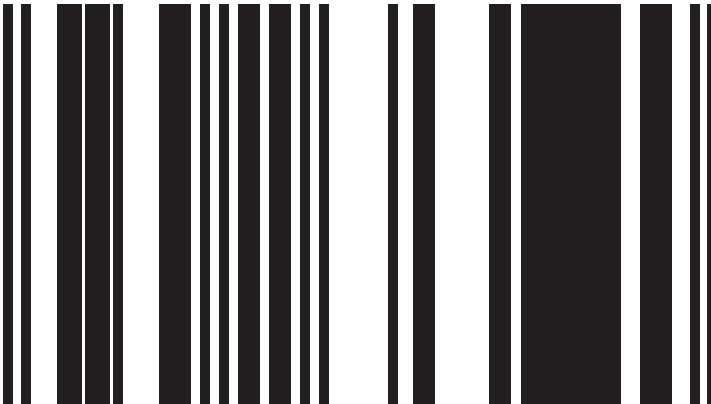

EVOLUTION WINE TOWER

The hyper modern Evolution Series Wine Tower continues our legacy of creating contemporary ways to display wine collections, label-forward.



How it Works

Included Hardware Everything you need to assemble! Add an Evolution Series Wall Bracket for added support.

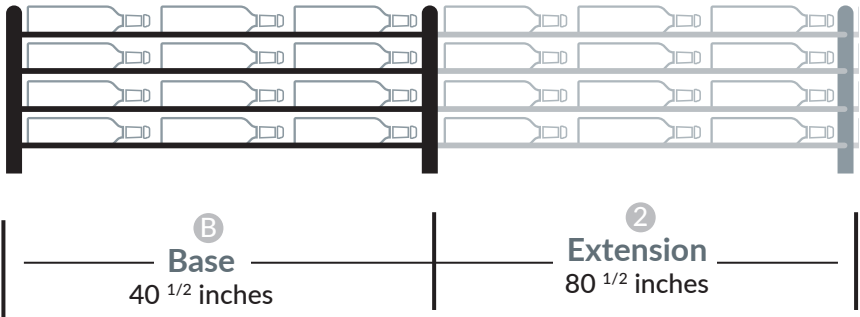

Share an acrylic panel! Start with a base unit, and expand to the side as many times as you need with Extension Units! The Evolution Series Studs connect Wine Rods through shared acrylic walls.

Or...

Order Evolution Series Wine Rods and hardware to create custom wine displays in millwork, metal, or any other material that can hold the weight of wine. Studs connect Wine Rods through shared common walls.

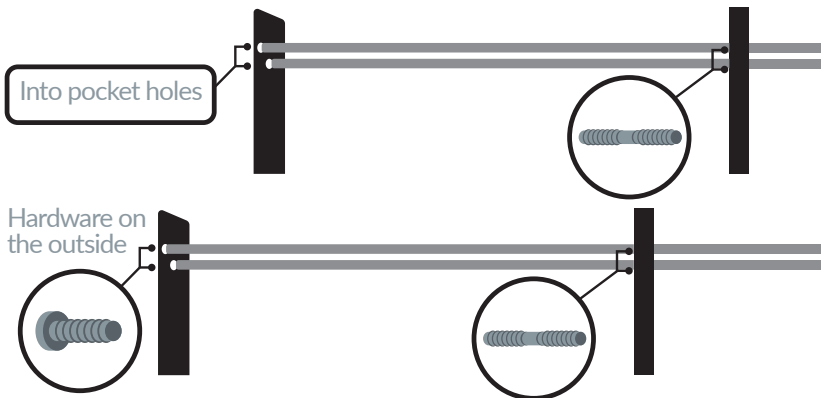

EVOLUTION WINE TOWER

Specs

Wine Tower 4

	Height	Width	Depth	Columns	Bottles
B	47 in	40 ^{1/2} in	13 ^{1/2} in	3	81
2	47 in	80 ^{1/2} in	13 ^{1/2} in	6	162
3	47 in	120 ^{1/2} in	13 ^{1/2} in	9	243
4	47 in	160 ^{1/2} in	13 ^{1/2} in	12	364

Wine Tower 6

	Height	Width	Depth	Columns	Bottles
B	72 in	40 ^{1/2} in	13 ^{1/2} in	3	126
2	72 in	80 ^{1/2} in	13 ^{1/2} in	6	252
3	72 in	120 ^{1/2} in	13 ^{1/2} in	9	378
4	72 in	160 ^{1/2} in	13 ^{1/2} in	12	504

Wine Tower 8

	Height	Width	Depth	Columns	Bottles
B	92 in	40 ^{1/2} in	13 ^{1/2} in	3	162
2	92 in	80 ^{1/2} in	13 ^{1/2} in	6	324
3	92 in	120 ^{1/2} in	13 ^{1/2} in	9	506
4	92 in	160 ^{1/2} in	13 ^{1/2} in	12	648

Finishes



Matte Black Finish



Chrome Finish

WINE WALL



The **Wine Wall** provides a unique approach to label-forward, wall-mounted storage, offering more spacing between racks to showcase beautiful wall treatments behind the racking.

Plus it stores standard, Champagne, and magnum bottles on the same rack!

EVOLUTION WINE WALL

Specs

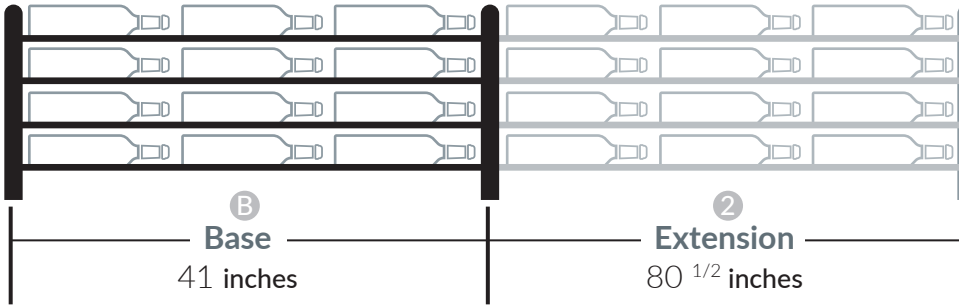

Wine Wall 5"

Height	Width	Depth	Columns	Bottles
B 5 in	41 in	Varies*	3	3, 6, 9,
2 5 in	80 ^{1/2} in	Varies*	6	6, 12, 18
3 5 in	120 in	Varies*	9	9, 18, 27
4 5 in	159 ^{1/2} in	Varies*	12	12, 24, 36

Wine Wall 15"

Height	Width	Depth	Columns	Bottles
B 15 in	41 in	Varies*	3	9, 18, 27
2 15 in	80 ^{1/2} in	Varies*	6	18, 36, 54
3 15 in	120 in	Varies*	9	27, 54, 81
4 15 in	159 ^{1/2} in	Varies*	12	36, 72, 108

*Depths

Single bottle: 4 1/8" | Double: 8 1/8" | Triple: 12 1/8"

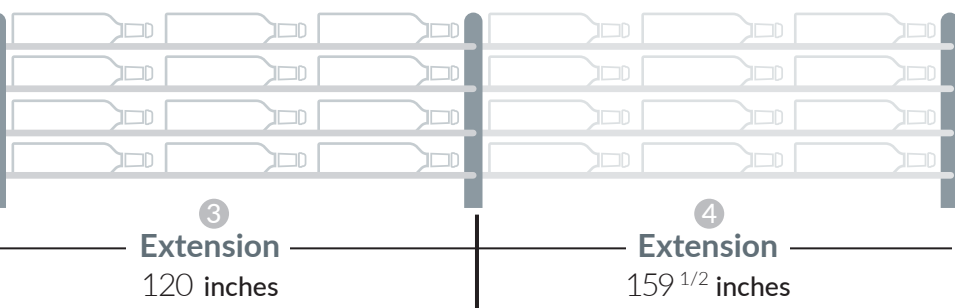

Wine Wall 30"

Height	Width	Depth	Columns	Bottles
B 30 in	41 in	Varies*	3	18, 36, 54
2 30 in	80 ^{1/2} in	Varies*	6	36, 72, 108
3 30 in	120 in	Varies*	9	54, 108, 162
4 30 in	159 ^{1/2} in	Varies*	12	72, 144, 216

Wine Wall 45"

Height	Width	Depth	Columns	Bottles
B 45 in	41 in	Varies*	3	27, 54, 81
2 45 in	80 ^{1/2} in	Varies*	6	54, 108, 162
3 45 in	120 in	Varies*	9	81, 162, 243
4 45 in	159 ^{1/2} in	Varies*	12	108, 216, 324

Wine Wall PR

Height	Width	Depth	Columns	Bottles
B 13 ^{1/4} in	41 in	13 ^{1/4} in	3	9
2 13 ^{1/4} in	80 ^{1/2} in	13 ^{1/4} in	6	18
3 13 ^{1/4} in	120 in	13 ^{1/4} in	9	27
4 13 ^{1/4} in	159 ^{1/2} in	13 ^{1/4} in	12	36

WINE WALL POST



The Wine Wall Post provides the ability to take the rack off the wall to create beautiful floor-to-ceiling displays in front of glass, in the middle of rooms, or anywhere else where wall access is at a premium.

CUSTOM

The Evolution Series offers a variety of custom options.

Wine Tower acrylic panels can come in a variety of depths, heights, widths, and layouts. Wine Wall and Wine Rods can be cut to any width!

Largest panel available: 119" tall (23 bottles) by 47" deep (~11 bottles).

Drill patterns and Bottle Layouts: Configure to almost any bottle layout

Width: Cut any Wine Rod down from 1 meter.

Design turnaround: 7-10 business days (some semi custom requests may be quicker)

Delivery: 4 to 6 week lead time on project delivery after approval.



EVOLUTION SERIES

Ordering/Skus

This is the product collection:

WS-W Series

E1/WW-Evolution Series

V-Vino Series

FCF-Floor to Ceiling Frames

IDR-Island Display Racks

GNR-Grain + Rod

CC-Case & Crate

Wine Tower Size:

4-47" unit

6-72" unit

8- 92" unit

E1-4-K
WW-301-K

Wine Rod Finish:

K-Matte Black

CH- Chrome

Wine Wall Height:

5-5"

15-15"

30-30"

45-45"

PR- Presentation Row

Bottle Depth:

1-Single

2-Double

3-Triple





VINTAGEVIEW | RESOURCE GUIDE