



VINTAGEVIEW

CATALOG 2020





THE PR CHO

Over the last two decades,
we have defined the
contemporary wine cellar
with label-forward metal
racking in homes and
restaurants from Newport
Beach to Paris.

WHAT'S INSIDE THIS BOOK:

- Neck & Base Advantage 4 • W Series 5
- Vino Series 17 • New Product Alert 18
- Evolution 29 • Case & Crate 41
- Island Display Racks 49 • Resources 57

WHAT'S INSIDE THIS CELLAR

W Series Wine Racks on W Series
Wine Rack Frames, 384 bottles,
Chrome finish, Beverly Hills, Ca.
Photo: Michael McNamara/ZenHouse Collective

PRO'S CHOICE

In the process, we have turned one amazing product into a full catalog of wine storage options trusted by the top professionals in the wine cellar, commercial and residential design, and architecture industries. These professionals continue to specify VintageView because we offer the best in design, quality, and customer experience. Best part: We serve up all of the above to you, regardless if you are a hospitality designer in Las Vegas or a DIYer in Upstate New York.

GET IN TOUCH:

303-504-9463

VintageView Design Center:

4690 Joliet St., Denver, Co 80239

VINTAGEVIEW.COM/CATALOG20

(includes all resources teased in this book!)



VINTAGEVIEW®
MOVING WINE STORAGE FORWARD



VINTAGEVIEW'S

NECK & BASE ADVANTAGE

5 reasons our original, patented design is still the **best** today

- 1** Perfect angle for wine aging
- 2** Specific impressions for neck and base offer more security
- 3** Offset rods provide the preferred designer look
- 4** 19-year track record of storing wine safely
- 5** Backed by a lifetime guarantee

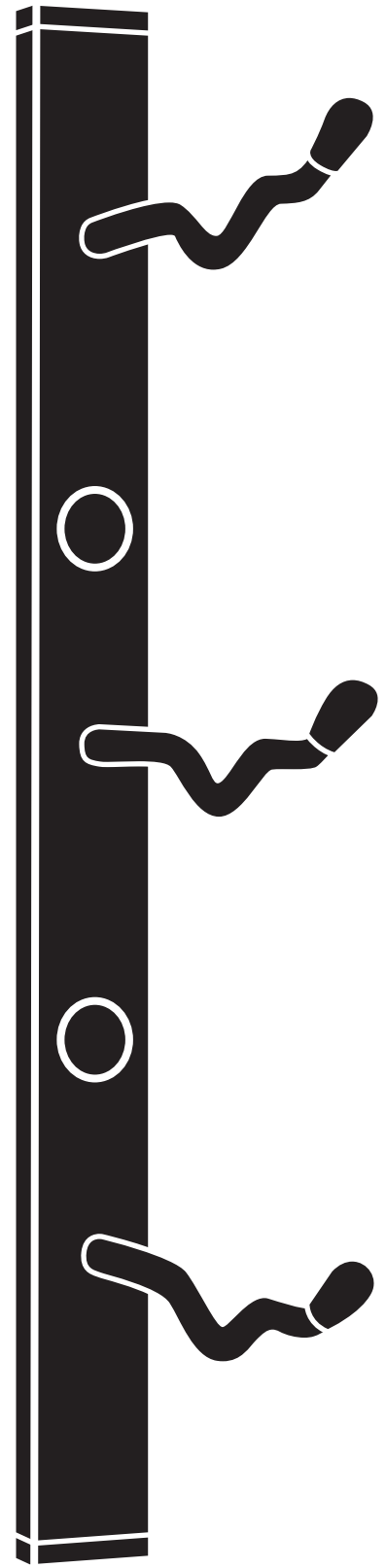

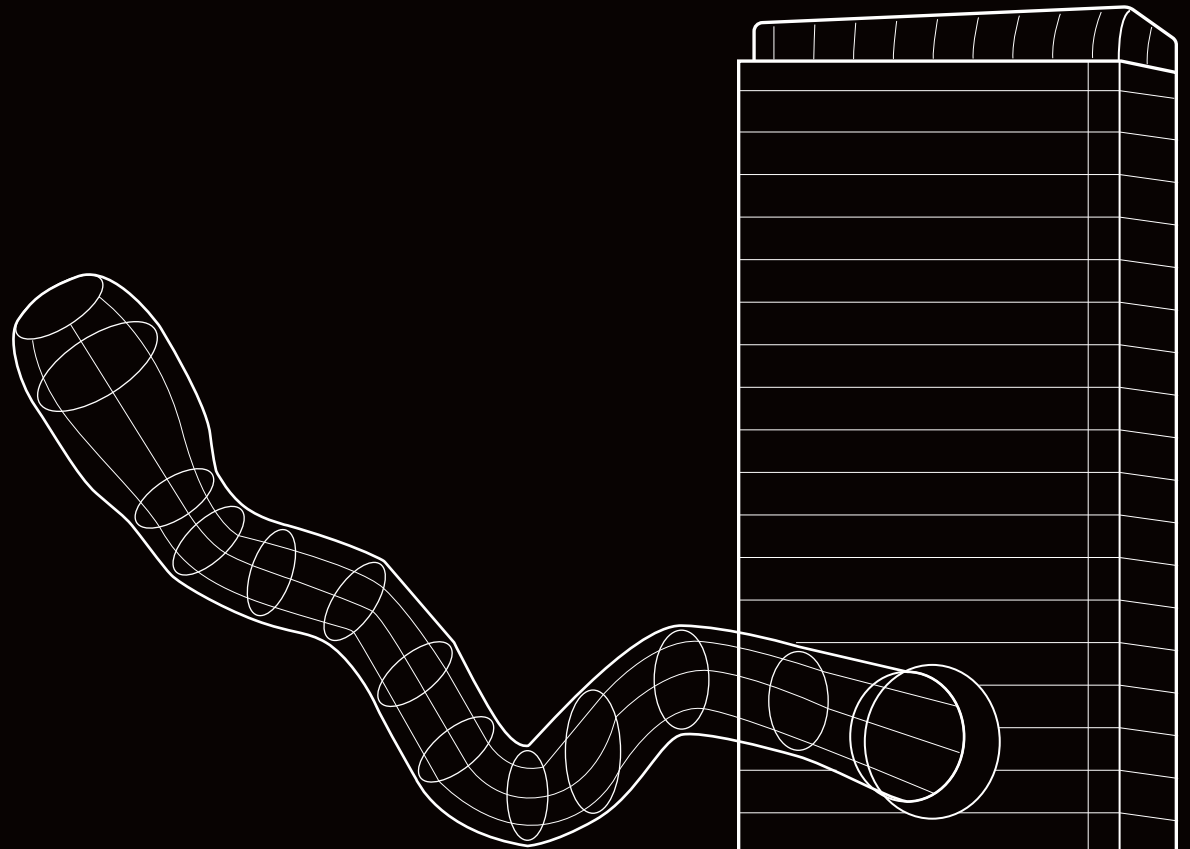

W Series

The best (and original) label forward rack.

The W Series started the mod wine rack movement in 2001 and maintains its design relevance today. Perfect for any size room — residential or commercial. Customizable to scale for wine collections of any size, starting at just a few bottles.

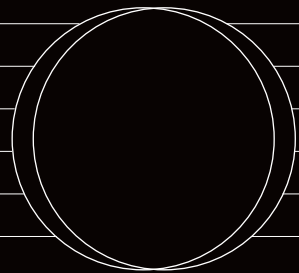



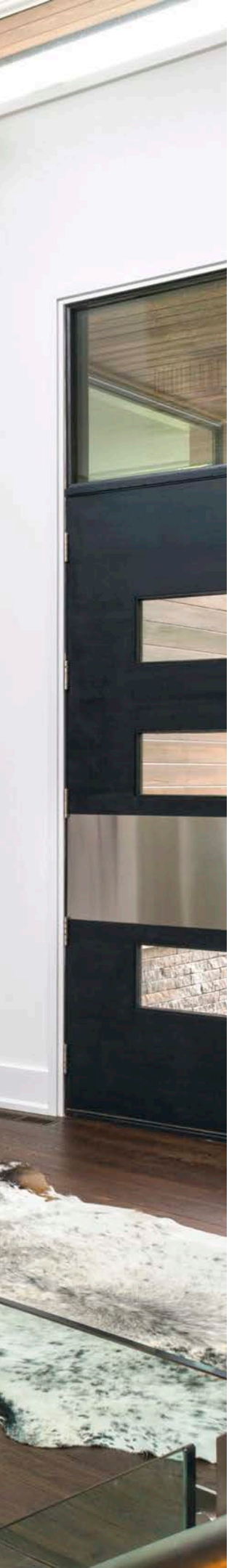

See-Through the Walls

Why stop at just one wine display? This Oakville, ON, residence showcases three unique floating wine walls that cleverly divide rooms.

Highlights

W Series wine racks, double deep
W Series Wine Rack Frames
Chrome finish
504 bottles
Design: Bachly Construction



Office Upgrade

It would be hard to judge the remote worker for getting distracted with this trendy wine cellar design that integrates into a West Palm, FL, home office.

Highlights

W Series wine racks, double deep
W Series Wine Rack Frames
Brushed Nickel finish
504 bottles
Design: Masterpiece Design Group
Photo: Studio KW Photography



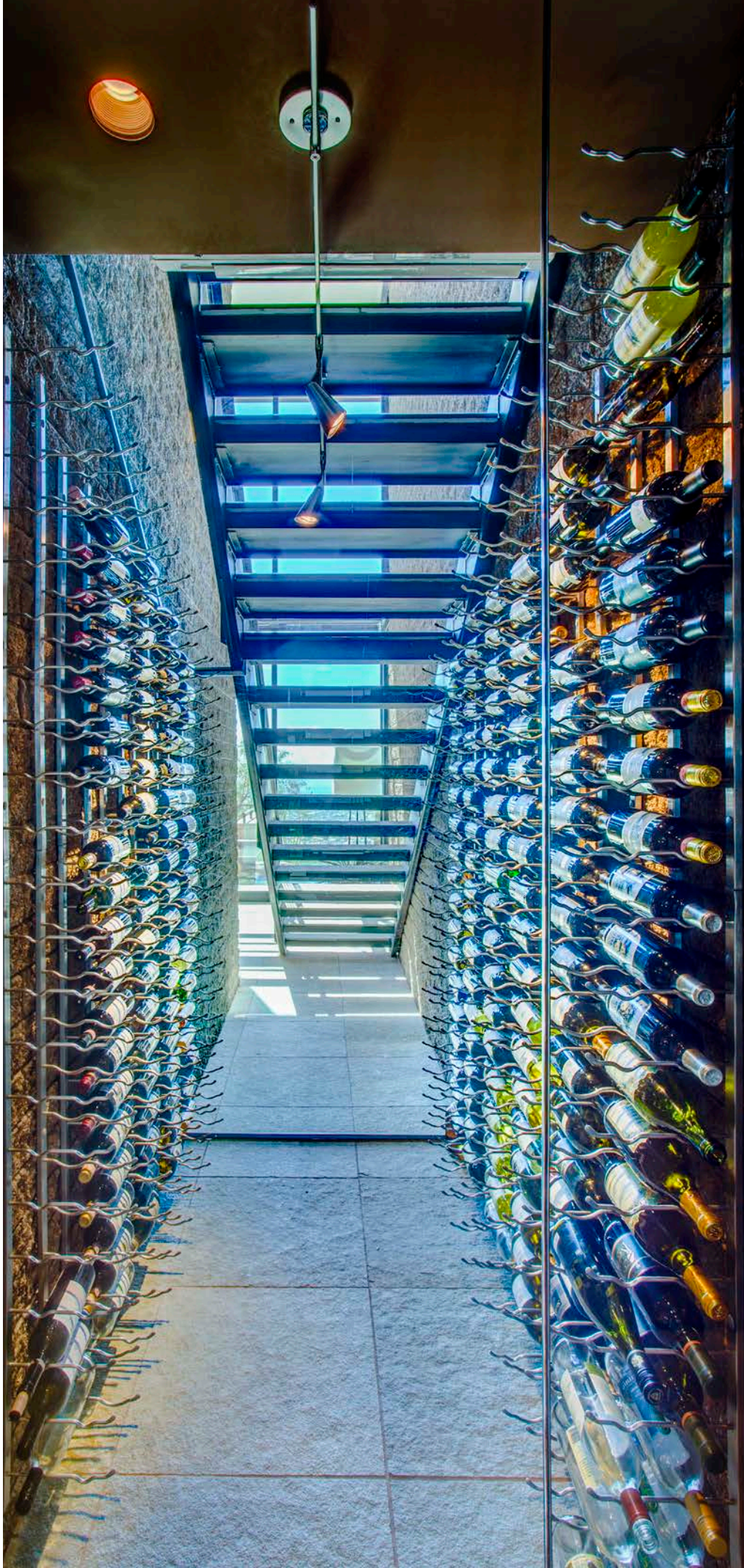

Innovative Use of Space

Highlighting the trend of transforming the awkward space beneath the stairs, this mountain estate in Tucson, AZ, uses label-forward display racking to beautifully fill a space behind glass.

Highlights

W Series wine racks, double deep
Brushed Nickel finish
336 bottles
Installed to stone
Design: Kevin B Howard Architects
Photo: Bill Lesch

Basque Inspired

Designed to match the vibe from the restaurateur's Spanish travels, the inside of Corrida (Boulder, CO) is as stunningly beautiful as its patio views of the nearby Flatiron mountaintops.

Highlights

W Series wine racks, single and triple deep
W Series Wine Rack Frames
Brushed Nickel finish
504 bottles
Design: Adam D. Tihany
Architect: Arch11
Photos: Raul Garcia/Astula





Restored Glamour

Inside the glamorous Breakers resort in Palm Beach, FL, HMF dazzles diners with its modern nostalgia created by an esteemed hospitality designer.

Highlights

W Series wine racks, single and triple deep
W Series Wine Rack Frames
Presentation Row accents
Chrome finish
2,184 bottles
Design: Adam D. Tihany
Photos: Eric Laignel



Embracing Engagement

Wine makes people happy. Wine walls make people want wine. It's science. Osteria Marco, Denver, CO. **Design: Jacqueline Bonanno.** Model: Allison Ruchaber. Photo: Kelsey Irwin. Wine display: W Series wine racks, W Series Wine Rack Frames, Satin Black finish, 840 bottles.

Old Meet New

The traditional wine cellar gets an inviting refresh in this gorgeous blend of wood bins, oak wine staves, and display racking. Sonoma, CA. **Design: Wine Racks America.** Photo: Beven Photography. Wine display: W Series wine racks, W Series Wine Rack Frames, Satin Black finish, ~1,000 bottles.



Walk-in List

Thirsty skiers après in style at this swank Vail Village institution. Sweet Basil, Vail, CO. **Design: Atlantis Architects.** W Series wine racks, W Series Wine Rack Frames, Satin Black finish, 2,000 bottles.

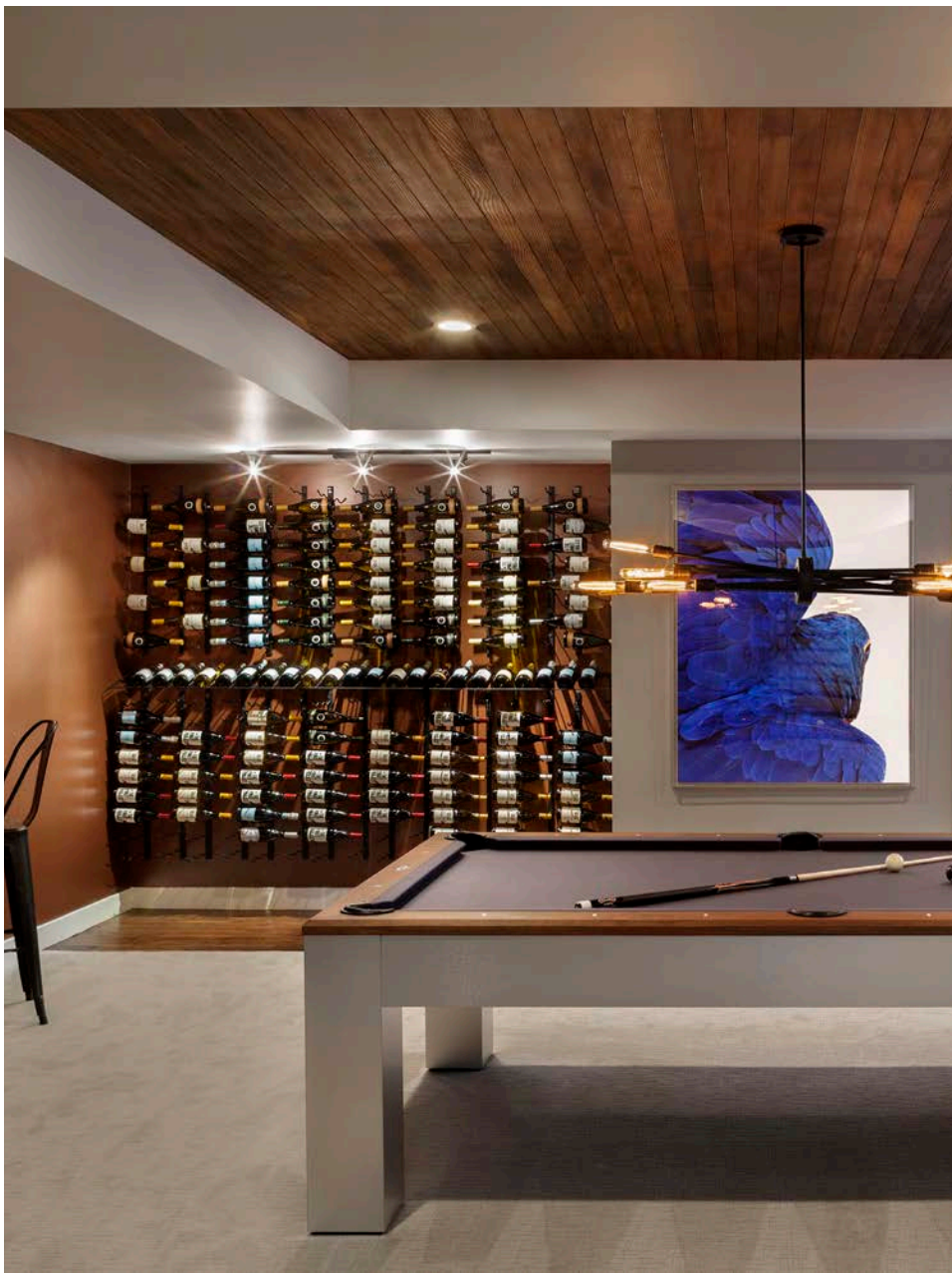

Designer Billiards

Pool gets better by the glass. Or bottle. Denver, CO. **Design: Caliber Construction.** Photo: Raul Garcia/Astula. Denver Life Magazine Designer Showhome selection. W Series wine racks, Satin Black finish, 384 bottles.

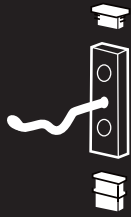

Bottle Height
(NEW!)



1'

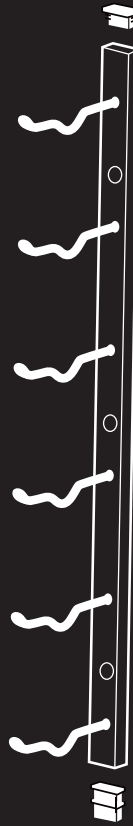

2'



3'



4'

The Original Label Forward

Finishes



Satin Black

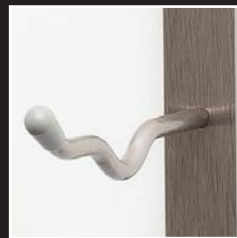

Brushed Nickel



Chrome



Chrome Luxe
(NEW!!!)

Create a Floating Wine Wall



1 Cut W Series Frame (on site) to fit ceiling height.



2 Pick W Series racking*.



3a Add W Series racking to one or both sides.



3b Add a backer bar to one-sided displays.

Standard Frames:
10'
12'
10' magnum

Custom Frames:
15'
Split bottles
3L+ bottles

Specs ...
Single Sided:
Add Backer Bar and 1.5"
to depth of racking

Double sided:
Add 1" to depth
of racking



Minimal
(single-bottle depth)
h: 5", 1', 2', 3', 4'
w: 13"
d: 5¼"
capacity: 1-12



Balanced
(double-bottle depth)
h: 5", 1', 2', 3', 4'
w: 13"
d: 8½"
capacity: 2-24



Maximum
(triple-bottle depth)
h: 5", 1', 2', 3', 4'
w: 13"
d: 12"
capacity: 3-36



Magnum Minimal
(single-bottle depth)
h: 45"
w: 15"
d: 5¼"
capacity: 9



Magnum Balanced
(double-bottle depth)
h: 45"
w: 15"
d: 10"
capacity: 18



Big Bottle ≤6L
(single-bottle depth)
h: 30"
w: 18"+
d: 8"
capacity: 4 (3L-6L)



Presentation Rows
h: 4"
w: 13" | 39"
d: 13"
capacity: 3 | 9



Stemware Racks
h: 4"
w: 13"
d: 6½" | 9½" | 13"
glasses: 2 | 4 | 6



Enlightened

A back-lit LED panel serves as art with bottles adding delicious inspiration in this Sarasota, FL, abode.



Highlights
W Series wine racks
W Series Wine Rack Frames
720 bottles
Brushed Nickel finish
Design: Kay Green Design
Builder: John Cannon Homes
Photo: Studio KW Photography

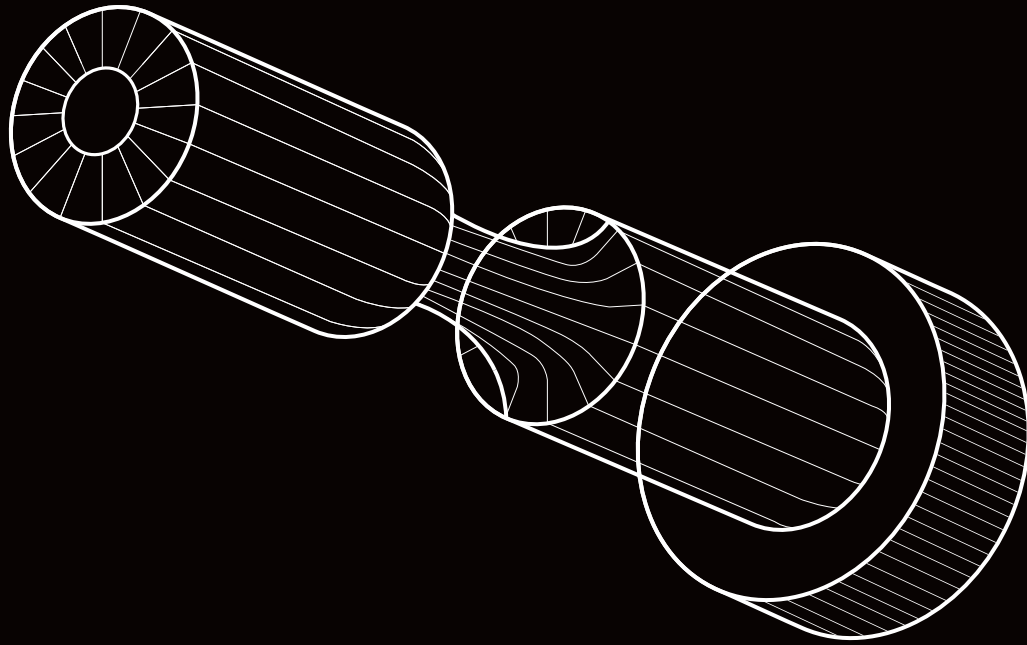

Vino Series

The artistic, minimalist approach to bottle storage.

The Vino Series turned label-forward on its head in 2015, quickly becoming the rack sought by the world's best designers. Start with one bottle, scale to hundreds. Coupled with a first-of-its-kind floating frame system (next page!!!), this collection allows layouts to break from the linear to transform wine cellars into art. There's no other wine rack like it.





New Vegas

We couldn't have selected a better home to launch the all new Vino Series Post and Panel systems, further elevating the best wine peg system in the world. Perched high above The Strip, this multi-million dollar estate in the exclusive Acaya development served as the prestigious The New American Home 2020 showcase.

Highlights

- Vino Pins wine pegs
- Vino Series Post (NEW!)*
- Vino Series Panel (NEW!)*
- Aluminum and Black finishes
- 504 bottles

Design: Sun West Custom Homes
Photos (cover too): Jeff Davis

Old Vegas

Not to be outdone, The New American Remodel show house — the renovation half of the 2020 International Builders' Show in Las Vegas — uses the new Vino Series Post with a smart bracket system to create an elevated display in front of beautiful tile.

Highlights

Vino Pins wine pegs
Vino Series Post (NEW!)*
Black and aluminum finishes
44 bottles
Design: Element Building Co.
Photos: Jeff Davis

* Patent pending





Proof Among Designers

Every year, the top design/build professionals collaborate on the annual Denver Life Magazine Designer Showhome. Every year, they select VintageView to display the wine. In this case, an elegant peg-style wall enticing billiards players to imbibe with a classic Bordeaux.



Highlights

Vino Pins & Rails wine pegs
Aluminum finish
80 bottles, 12 stems

Design: Caliber Construction
and Inspire Kitchen Design Studio
Photos: Emily Minton Redfield

Just Add Wine

Beautiful, even without bottles.
And practically invisible. There's not a more minimal way
to showoff stellar vintages than this Dallas, TX, room.



Highlights

Vino Pins wine pegs

Acrylic finish

120 bottles

Design: Castletop Construction



Farmhouse Vibe

Speaking to the heart of the transitional movement, this wine feature blends new and old in Clay, NY. The contemporary peg-style racking vibrantly displayed behind glass mixes well with the warmth of the dining table, rug, and color palette. Bravo.

Highlights

Vino Pins wine pegs
Black finish
40 bottles
Design: WineRacks.com

Engrained

Wood wine crates combine with black Vino Pins to form a winning look. Villanova, PA. Design: Meera Thomas Interiors. Builder: Integrated Design Construction. Photo: Donna Rizzo. Wine display: Vino Pins wine pegs, double deep, black finish, 128 bottles.



Bucking Tradition

Cork-forward doesn't mean sacrificing aesthetics. Wood and metal blend beautifully in this Castle Rock, CO, home. Photo: Jennifer Ferris. Wine display: Vino Rails wine pegs, Aluminum finish, 76 bottle + wood bins.



Love of Marble

Marble is the focus of this haute dining room. But it has to share the spotlight with the subtly chic pegs holding a few dozen bottles. Vista, CA. **Design: Vista Wine Cellars.** Wine display: Vino Pins wine pegs, 77 bottles, Aluminum finish.

Top Shelf

This entertaining zone brings people together with its gorgeous display of our contemporary, cork-forward peg system. Thirsty? Denver, CO. Denver Life Magazine Designer Showhouse selection. **Design: Caliber Construction.** Wine display: Vino Rails wine pegs, 32 bottles, Aluminum finish.



with collars for drywall installation

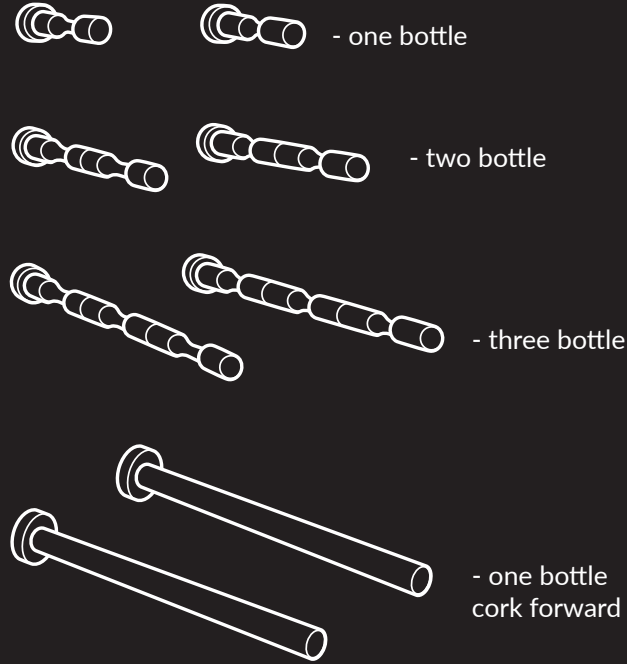
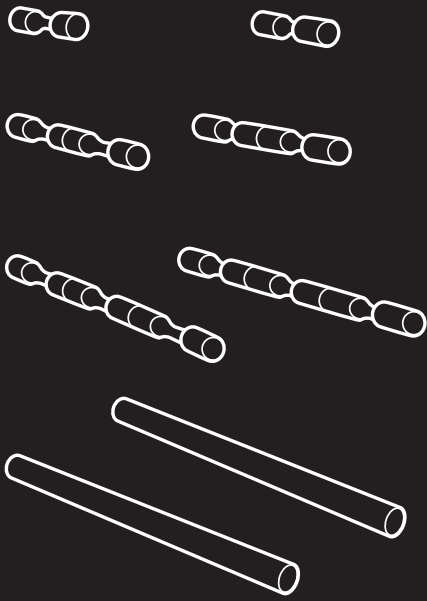

The Ultimate Wine Peg System

Finishes



Golden Bronze (NEW)



Black



Gunmetal (NEW)



Aluminum



Acrylic

Create a Floating Wine Wall (NEW!)

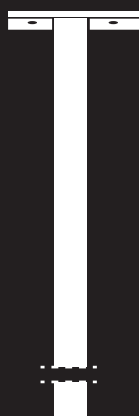

1 Cut the Vino Series Post** (on site) to fit your ceiling height.



2 Pick your Vino Pins* or Rails and attach them to a Vino Series Plate.

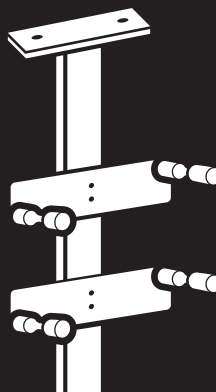

3 Add Plate and Peg combos to the Post.



4 Install finished Post against glass or in the middle of rooms.



Minimal

Standard or Mag bottles
(single-bottle depth)
h: 5" standard/
6" mag
w: 13"/14"
d: 4"
capacity: 1



Balanced

(double-bottle depth)
h: 5"
w: 13"
d: 8"
capacity: 2



Maximum

(triple-bottle depth)
h: 5"
w: 13"
d: 12"
capacity: 3



Magnum Balanced

(double-bottle depth)
h: 6"
w: 14"+
d: 8½"
capacity: 2 (1.5L)



Standard Bottle

(single-bottle depth)
h: 5"
w: 3"
d: 13"
capacity: 1



Magnum Bottle

(single-bottle depth)
h: 6"
w: 3"
d: 13"
capacity: 1

Black & White

Stunning visual depth is created by using a classic black and white combo in this Rancho Santa Fe, CA, residence. The climate-controlled room features a dark wallpaper backdrop that plays off the stark contrast of the wet bar.

Highlights

Vino Pins wine pegs

74 bottles

Aluminum finish

Design: Preston Development



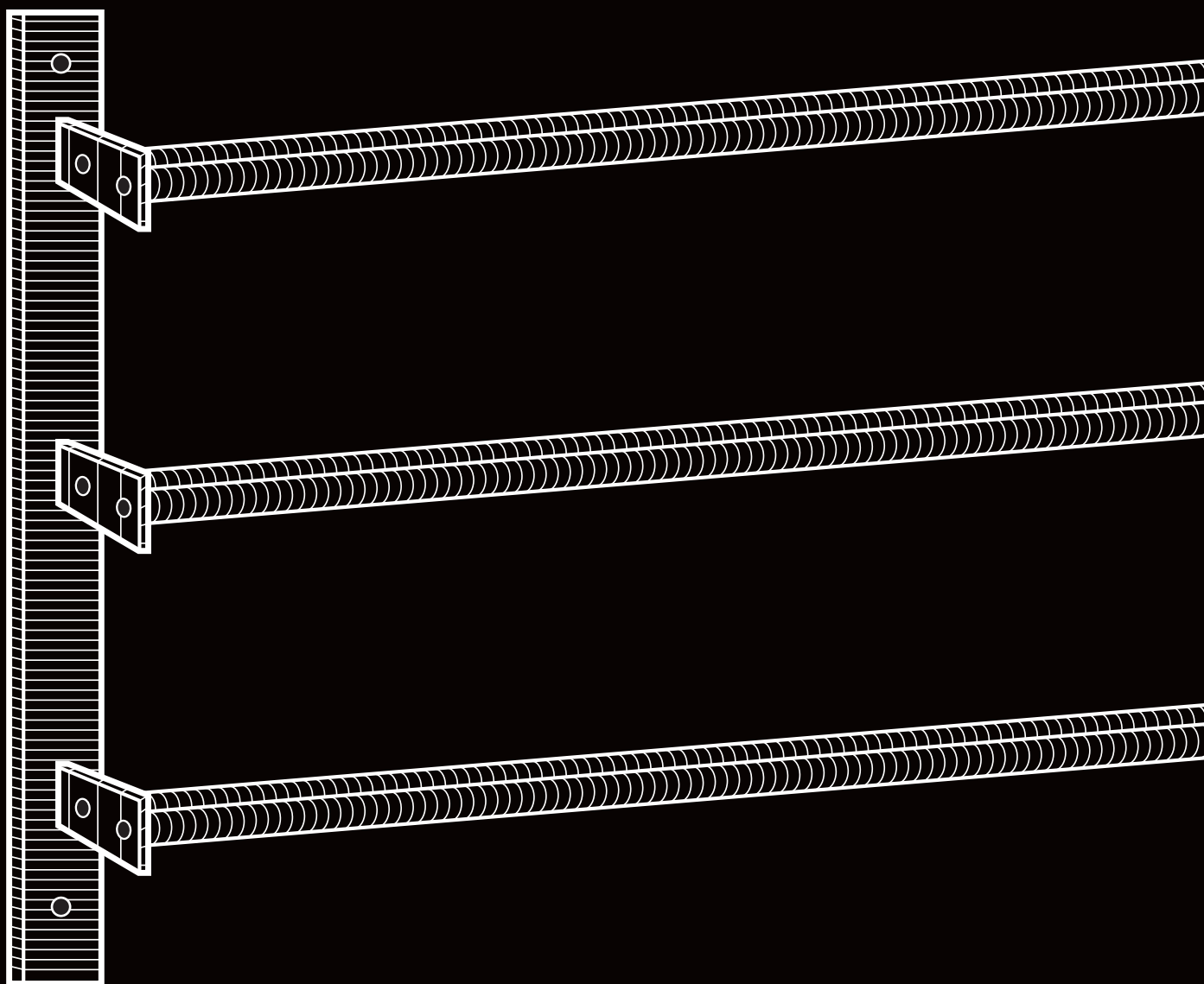

Evolution

The designer tool bag expands with the versatile Evolution collection.

Featuring three unique systems of wine racking, Evolution allows myriad ways to display bottles in freestanding and wall-mounted fashion.



All Mod, All Day

Hard to imagine a better way to display wine against glass, allowing for a near transparent storage that subtly reveals two Wine Wall installations on our all new Post system. The first floats in front of a stark white wall, the second presses a display against glass. We call this room home. Literally.

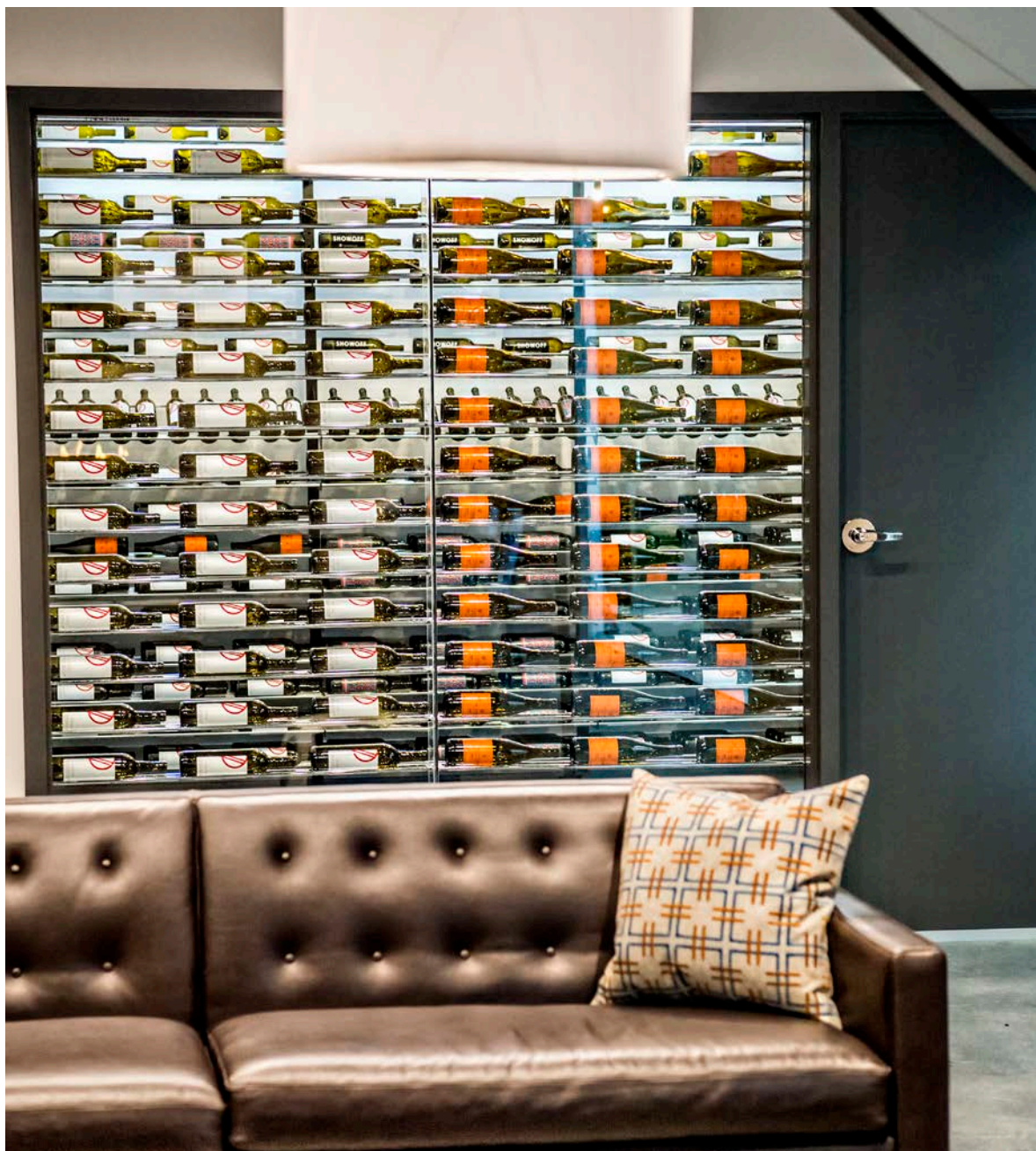

Highlights

Evolution Wine Wall system on Wine Wall Posts*

Custom Evolution Wine Tower, single deep

Satin Black and Chrome finishes

585 bottles

Design: Jacqueline Craine Designs

Photos: Jonathan Phillips

* Patent pending

Don't Hide That Wall



The Evolution Wine Wall system shows its design panache in this concept cellar allowing the industrial black steel to support wine by the caseload without disrupting the view to tasteful wood walls.



Highlights

Evolution Wine Wall system,
double deep
Satin Black finish
720 bottles

Under the Shiplap

With a staircase feature this tall, what better way to make use of the unique space it creates below than a glass-enclosed wine feature? This Morristown, NJ, house hits on the transitional design trend with an epic blend of steel, wood floors, and shiplap.

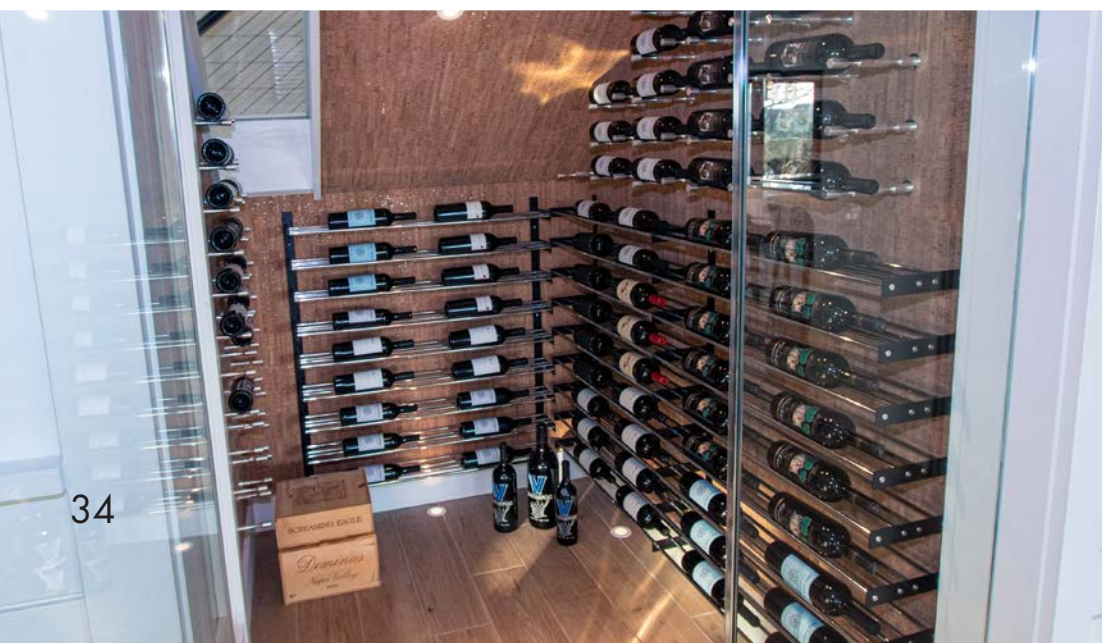
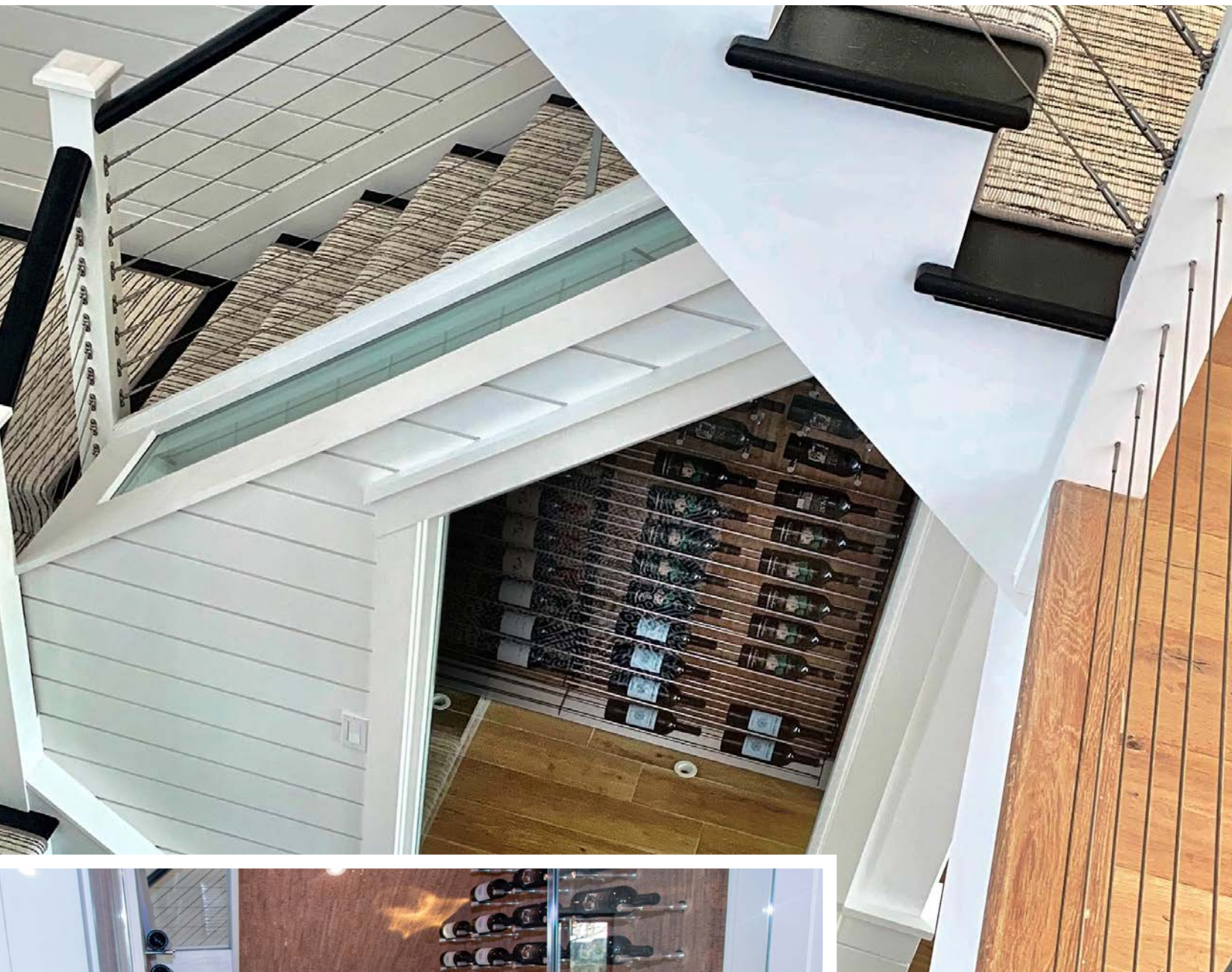

Highlights
Evolution Wine Wall
Vino Pins wine pegs
Satin Black, Chrome,
Aluminum finishes
198 bottles



Kitchen Upgrade

Customized acrylic panels scale this Wine Tower to fit perfectly in a kitchen ready for entertaining. The glass box ensures there's no hiding the beauty.

Highlights

Wine display: Evolution Wine Tower (custom), Chrome rods, 228 bottles.

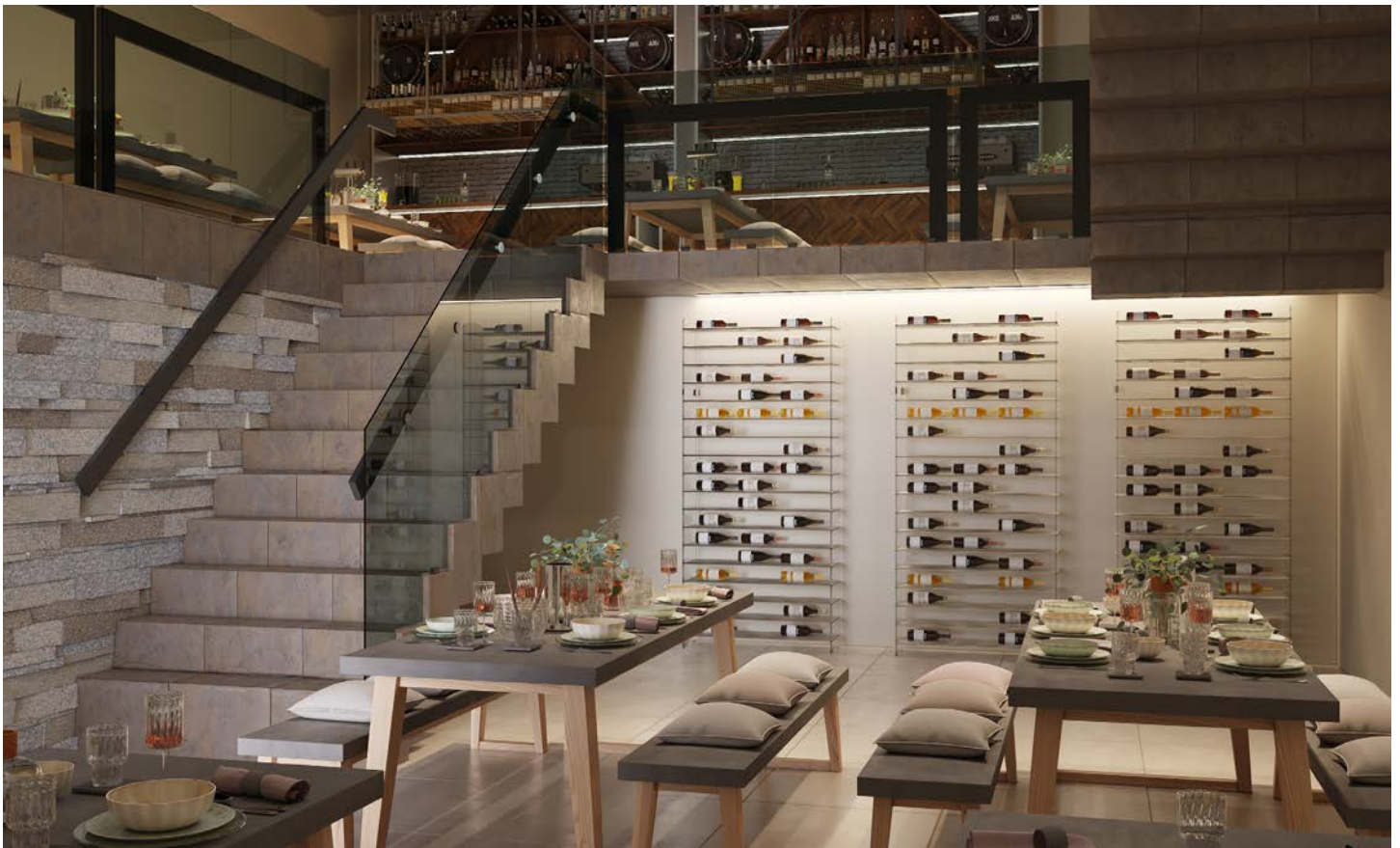

Wine Case

The Wine Tower is the boozy version of a bookcase, allowing diners to peruse the wine list as if they were looking through a tasty library. The minimalism adds to understated design throughout a concept restaurant.

Highlights

Wine display: Evolution Wine Tower 8, Chrome rods, 486 bottles.

Spot on Showcase

In the heart of Chicago, IL, a premier custom door fabricator puts on a show with two unique wine displays in its Showcase.

More about VintageView Showcases on page 62.



Highlights

Evolution Wine Wall

Vino Rails, Vino Magnum Rails & Vino Pins wine pegs

Black, Aluminum, and Chrome finishes

126 bottles

Design: Glenview Haus

Evolution WINE TOWER

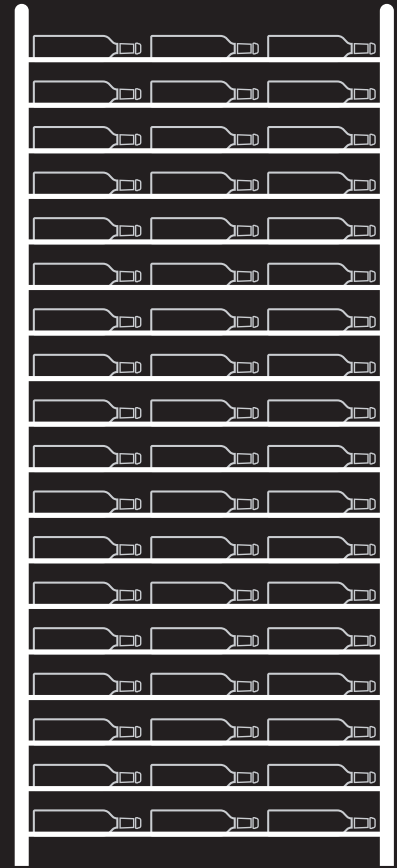
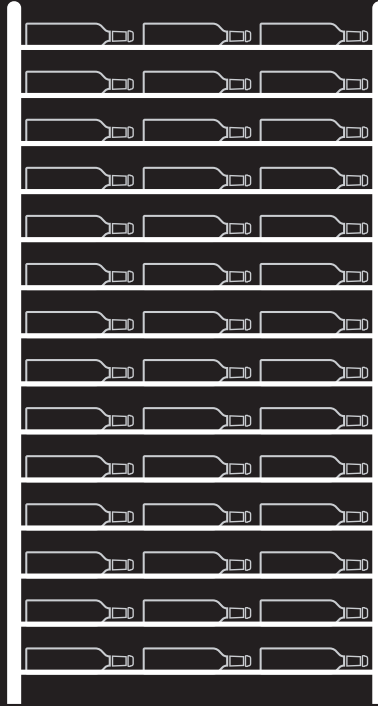
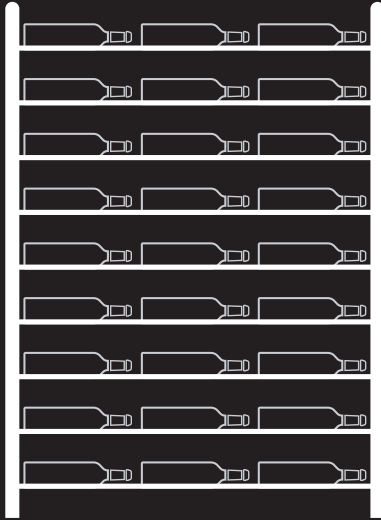

Wine Tower 4

	Width	Columns	Bottles
B	40 1/2 in	3	81
2	80 1/2 in	6	162
3	121 in	9	243
4	160 1/2 in	12	364

Wine Tower 6

	Width	Columns	Bottles
B	40 1/2 in	3	126
2	80 1/2 in	6	252
3	121 in	9	378
4	160 1/2 in	12	504

Wine Tower 8

	Width	Columns	Bottles
B	40 1/2 in	3	162
2	80 1/2 in	6	324
3	121 in	9	506
4	160 1/2 in	12	648

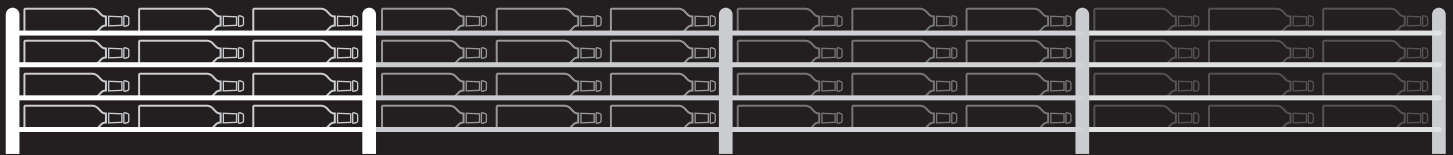

B
Base
40 1/2 inches

2
Extension
80 1/2 inches

3
Extension
121 inches

4
Extension
160 1/2 inches

Finishes:



Chrome Rods | Clear Acrylic



Satin Black Rods | Clear Acrylic

Evolution WINE WALL



bottle depth options:
single 4 1/8" | double 8 1/8" |
triple 12 1/8"



Presentation Row

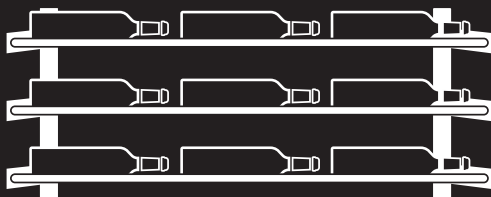

15"



5"

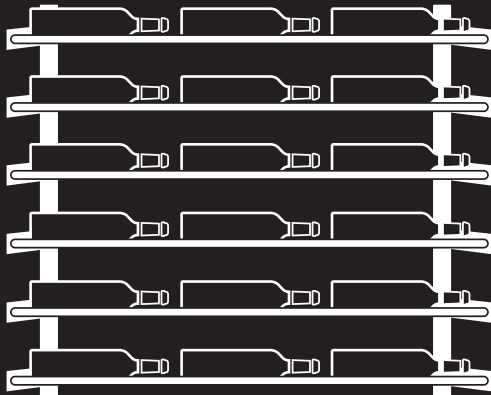

30"

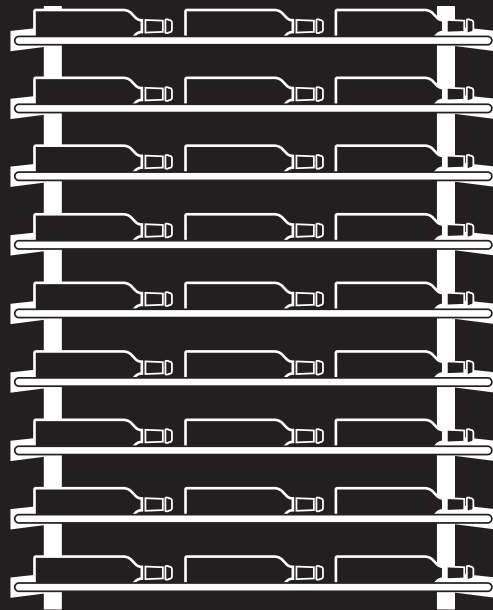

45"

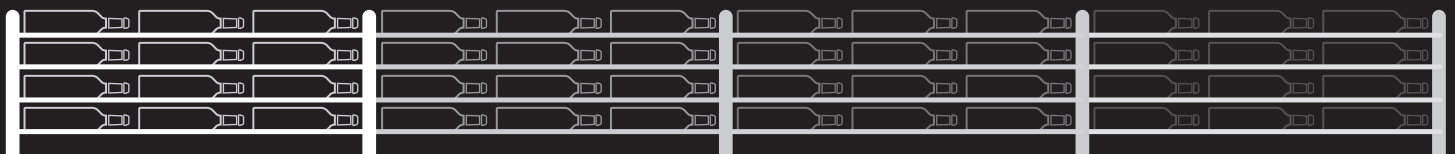

B

Base
41 inches

2

Extension
80 1/2 inches

3

Extension
120 inches

4

Extension
159 1/2 inches

Create a Floating Wine Wall (NEW!)



1 Select the proper number of Wine Wall Posts**. Two for a base unit; one for each extension.



2 Cut the Wine Wall Series Post (on site) to fit your ceiling height.

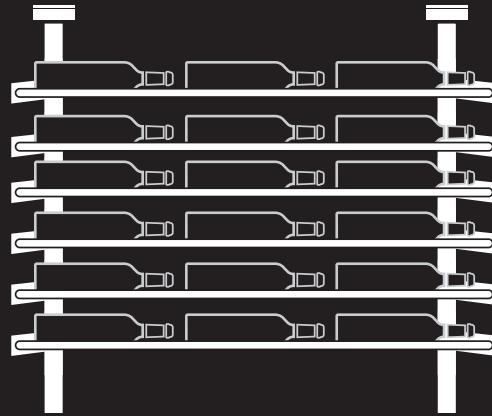

3 Install Wine Wall racking to the Posts against glass or in the middle of rooms.

Finishes:



Satin Black Frames | Chrome rods



Satin Black Frames | Satin Black rods

Evolution WINE RODS

How it works:

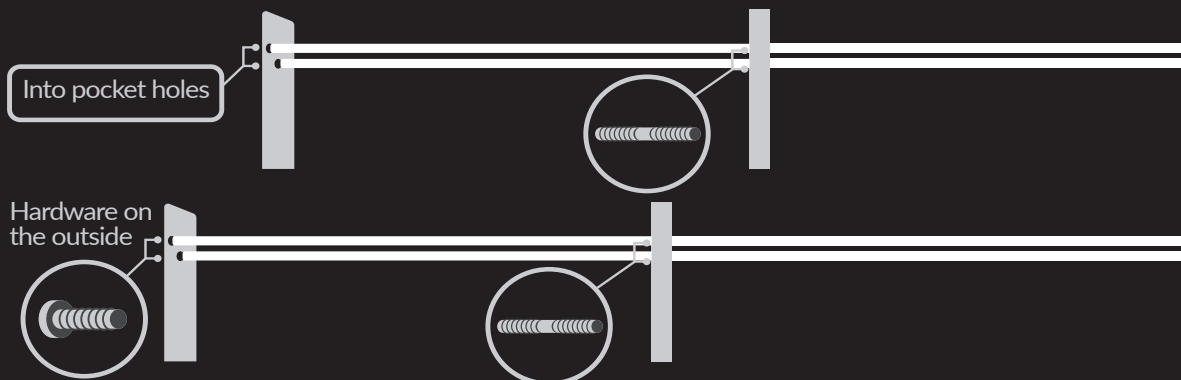

** Patent pending



Got Milk?

The Milk Market in the trendy Lower Downtown neighborhood of Denver, CO, is home to more than a dozen tasty food concepts by a legendary local chef. Our favorite stop, however, is where they pour the wine. The Cellar uses a skinny, 4" wide custom Evolution Wine Tower to stretch its bottle displays between rooms and up walls. Stunning.

Highlights

Evolution Wine Tower (custom)
W Series Stemware
Chrome & acrylic finishes
465 bottles, 104 glasses
Design: Jacqueline Bonanno
Photos: Ryan Dearth (above)
& Kelsey Irwin (right)



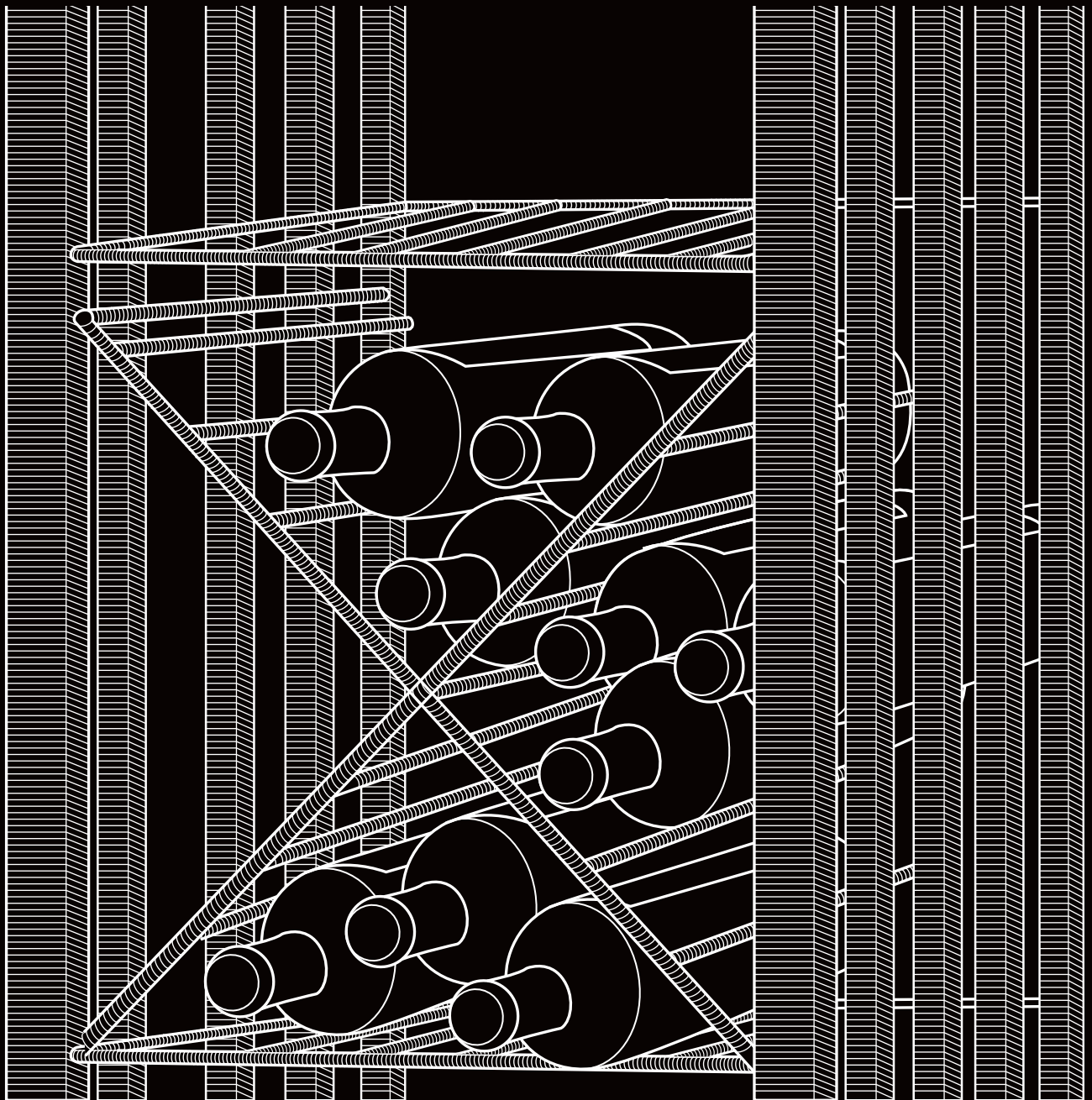

Case & Crate

A Case Study

This chic line brings VintageView's renowned ingenuity to bulk wine storage.

It also ships same day so you can design well — and quickly.

Just call this the first Locker and Bin system that designers actually like.

Perfect on its own or with VintageView's other display racking collections.





Statement Wall

When creating our Design Center, we knew it had to be anchored by a statement feature. This Locker and Bin collection allows designers to dream about integrating elegant case storage into a “jewel box” display. Our W Series racks provide a Champagne accent.

Highlights

Case & Crate Bins & Lockers

W Series Champagne racks

Satin Black finish

1,472 bottles

Design: Jacqueline Craine Designs

Photos: Jonathan Phillips

Pinot Branding

In a crowded Pinot region, it's important for boutique wineries to stand out to tasting room crowds. Lange Winery in Dundee, OR, does just that by putting its world-class Pinots & Chardonnays on display, label out, in Bins and W Series column racking. Enjoy wine. Stare at bottles. Bring a case home. That's how a winery builds brand loyalty.

Highlights

Case & Crate Bins
W Series wine racks
Satin Black finish
1,014 bottles
Photos: Marissa Yuhas/
M.N.F. Photography

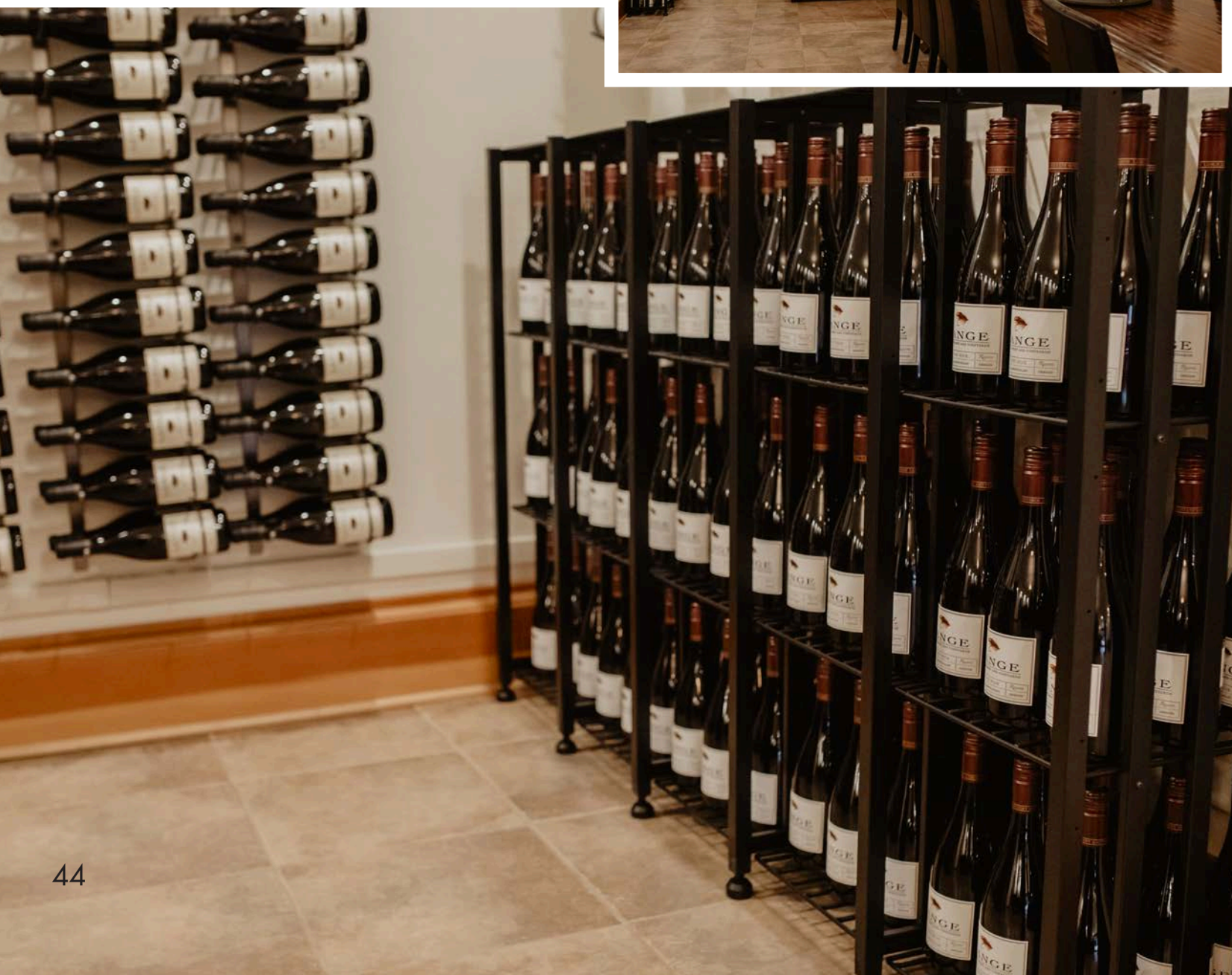
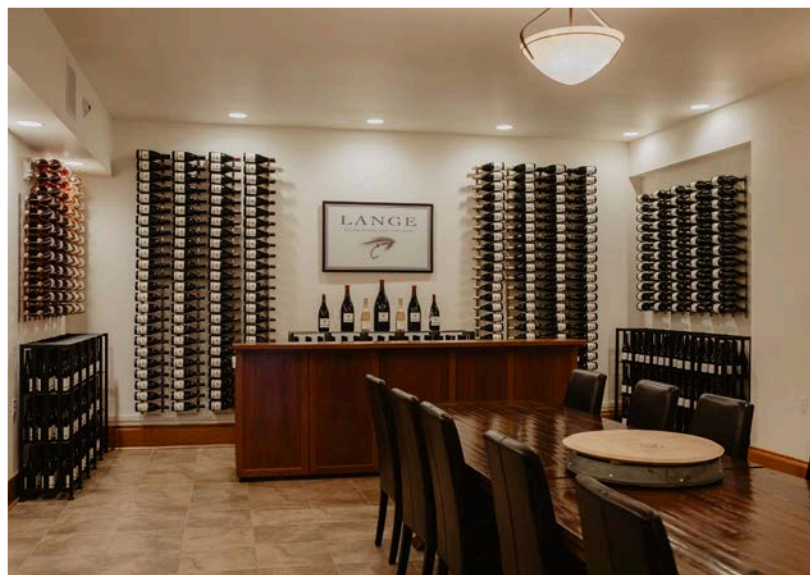



Private Dining

The hidden room perfect for a momentous occasion. What wine lover wouldn't want to host an event here?

Highlights

Wine Display: Case & Crate Lockers, W Series wine racks, W Series Wine Rack Frames, 1,680 bottles, Satin Black finish.



Pedaling Cases

Two compact Lockers provide needed storage and show how well the secure cubes blend with our label-forward style. Denver Life Magazine Designer Showhouse selection.

Highlights

Design: Caliber Construction.
 Photographer: Raul Garcia.
 Wine Display: Case & Crate Lockers, W Series wine racks, W Series Wine Rack Frames, 270 bottles, Satin Black finish.

Wine Lockers with Mod Sensibility

Accessories

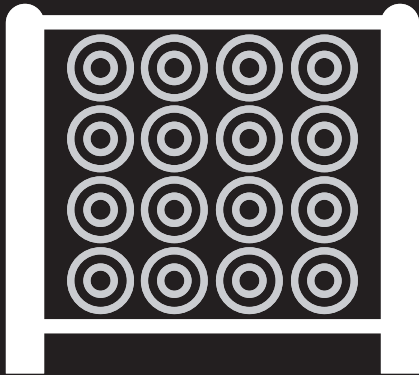

Bin

Open concept, lots of storage.

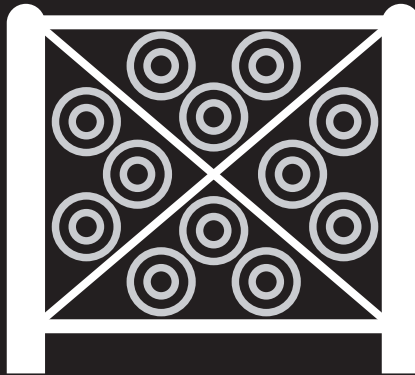

X-Bin Insert

Aesthetic enhancement to any Bin or Locker.

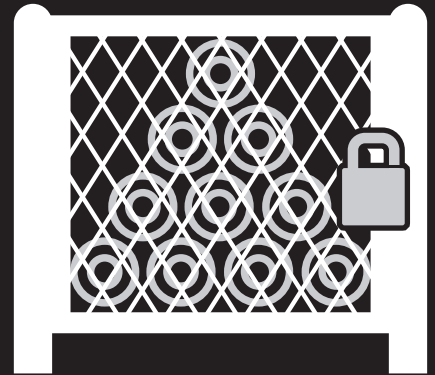

Locker Door

Upgrade any Bin – now or later – with a grated door.

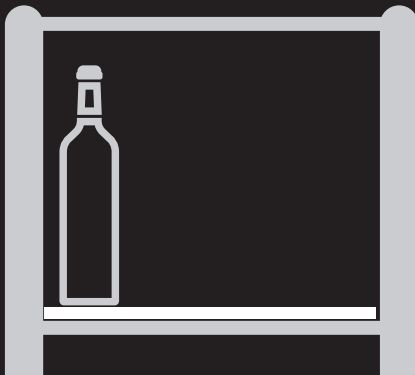

Syrah Shelf

Have a favorite winery? Stand that bottle up to show it off in the middle of any Locker or Bin run.

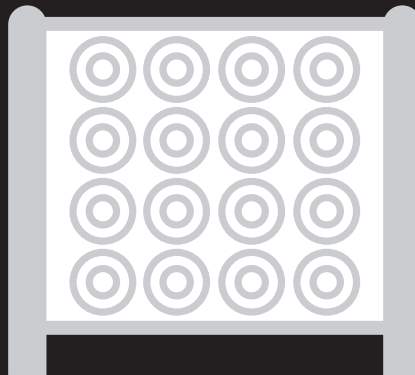

Back Plate

A simple steel sheet that closes off the back of any Bin or Locker. Provides a new aesthetic and further security.



depth
14^{3/8}"

Finish Option:



Satin Black

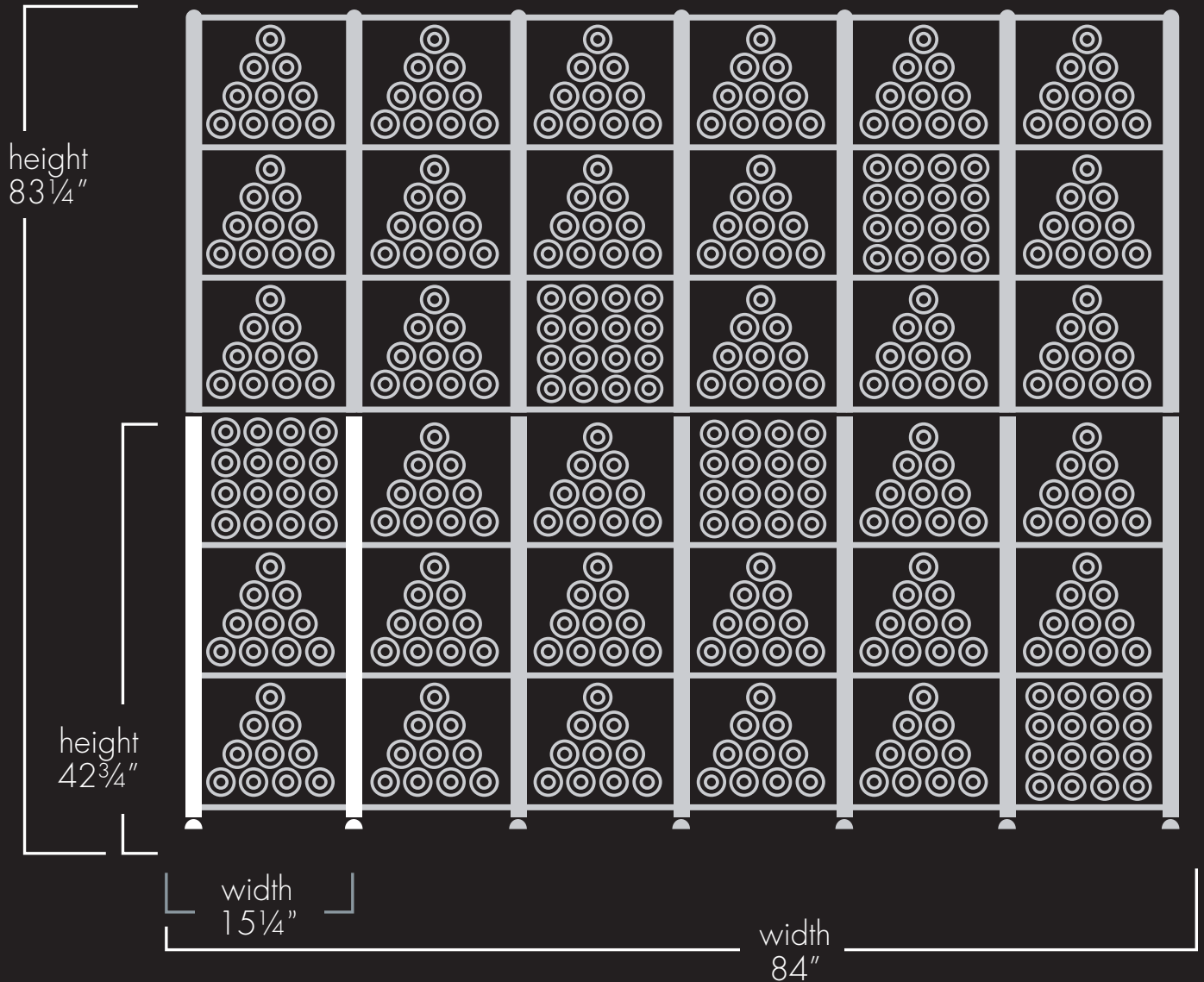

Did You Know?

High-end restaurants often add wine lockers to either gift or rent to clients, ensuring they come back more often to open the bottles they store. Great way for wine pros and wine lovers to interact!

Hidden in Plain Sight

A row of lockers ramps up the bottle count while the Vino Pins do the heavy (design) lifting. No need to sacrifice form or function in this stellar wine cellar located inside the VintageView Design Center.

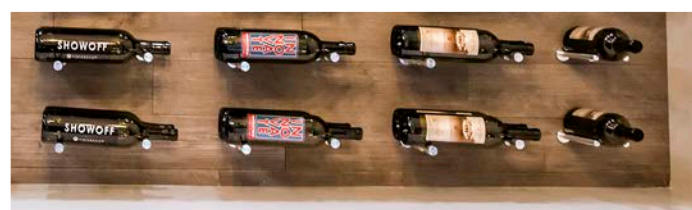
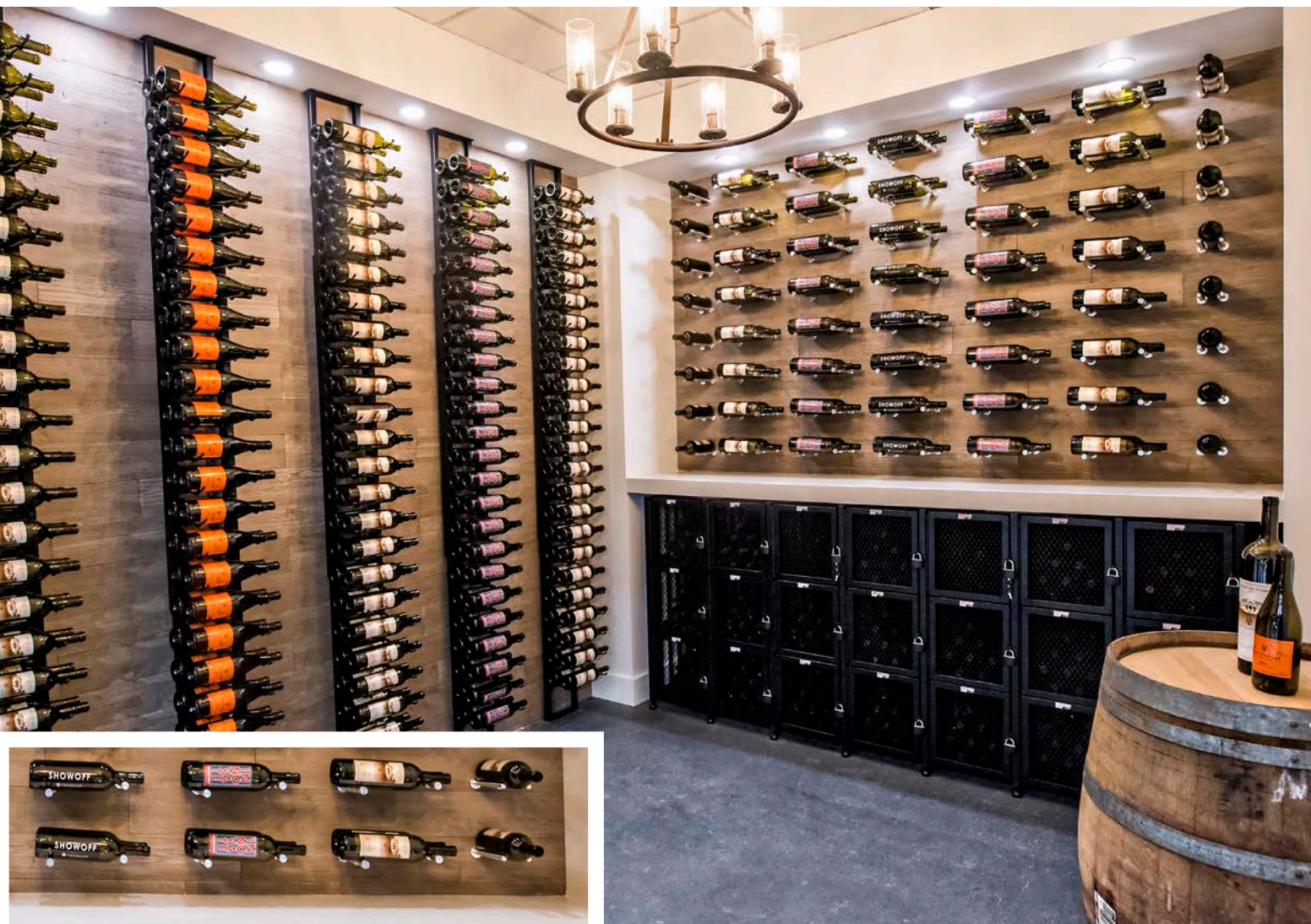

Highlights:
Case & Crate Lockers
Vino Pins wine pegs
W Series wine racks
W Series Wine Rack Frames
Satin Black and Aluminum finishes
672 bottles
Design: Cellar Masters
Photo: Jonathan Phillips

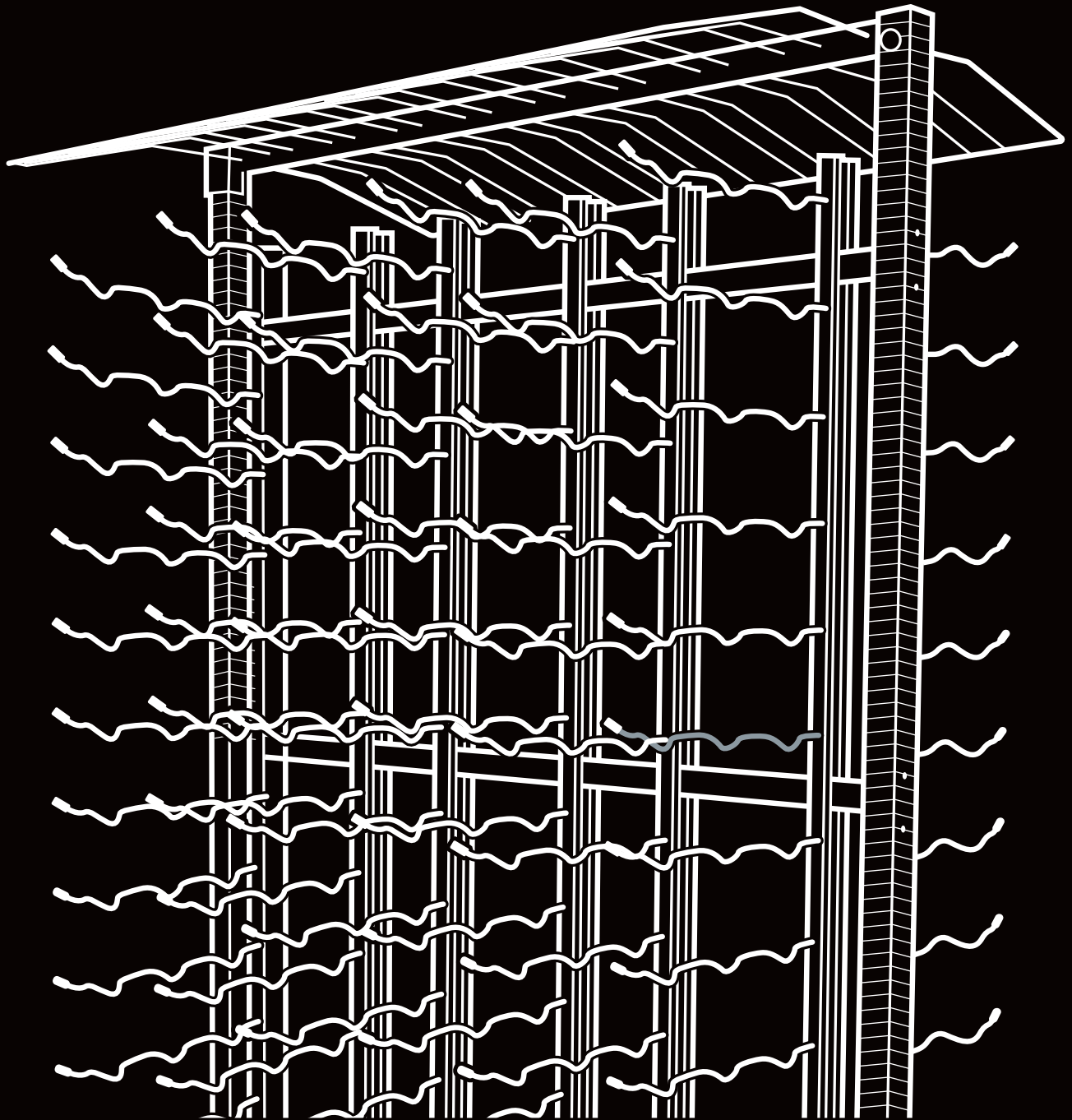

Island Display Racks

Boutique Redesign

Wine shops of all flavors are leaning on label-forward design to entice shoppers in every aisle. The Island Display Rack is the solution that balances retail practicality with a style that improves the customer experience. Win-win.





Design Aisle

This mega-store in Edmonton, AB, emphasizes aesthetics every bit as experience. The result being a store that packs in bottles while still maintaining a look befitting of an interior design studio.

Highlights

- Island Display Racks
- IDR Endcaps
- W Series wine racks
- Satin black finish
- 4,035 bottles

Design: Laurie Griffiths Interior Design
Photos: Tracey Jozmin

Getting Social

There is hardly better proof of product than a high-end wine shop expanding, and doubling down on VintageView's chic Island Display Rack series (and adding an Evolution Wine Wall). Social, a boutique with two Boston locations, utilizes IDRs to create label-forward aisles that entice its savvy clientele.

Highlights

- Island Display Racks
- IDR Extensions
- Evolution Wine Wall
- Satin black finish
- 2,736 bottles



Flexible Design

With a wide-open floorplan, often used for events, Michael's Wine Cellar in Sarasota, FL, uses IDRs on Castors to allow for great design that can move when needed!

Highlights

Wine display: Island Display Racks, IDR Extensions, IDR Casters, Satin Black finish, 1,404 bottles

Regional Layout

Labels on the wall, labels in the middle. This concept shows how well the VintageView neck and base design integrates in freestanding and wall-mounted configurations.

Highlights

Wine display: Island Display Racks, IDR Extension, W Series wine racks, Satin Black finish, 738 bottles



Retail Racking with panache

Accessories

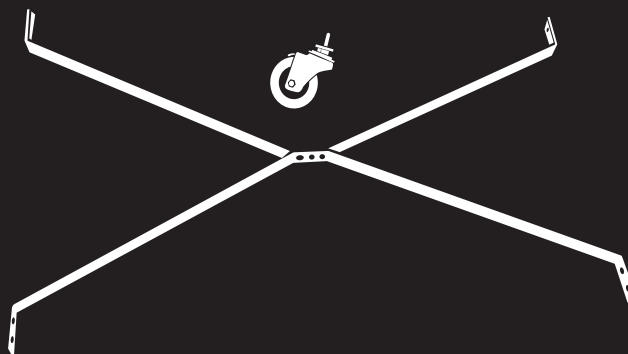

IDR Caster Kit

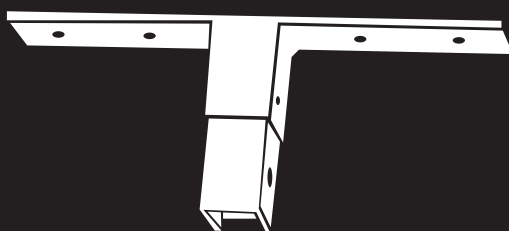

2" Shelf Bracket

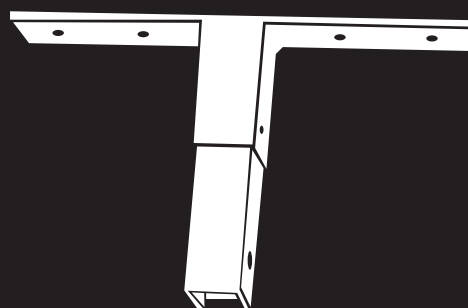

6" Shelf Bracket



Snap Price Tag Holder



Rod Price Tag Holder

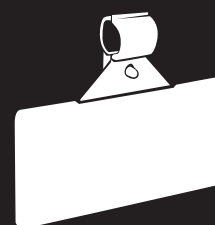

Foldover Price Tag Holder

Finishes:



Satin Black



Brushed Nickel

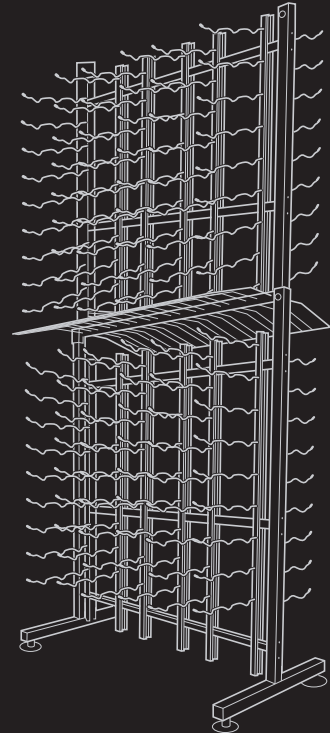
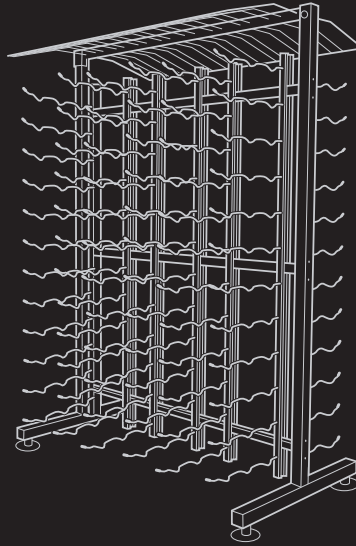
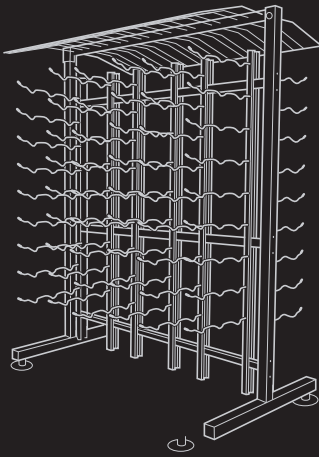

IDR 3 Kits*

	Width	Columns	Bottles
B	40 1/2 in	3	180
2	79 1/2 in	6	360
3	118 1/2 in	9	540
4	157 1/2 in	12	720

IDR 4 Kits*

	Width	Columns	Bottles
B	40 1/2 in	3	234
2	79 1/2 in	6	468
3	118 1/2 in	9	702
4	157 1/2 in	12	936

IDR 7 Kits**

	Width	Columns	Bottles
B	40 1/2 in	3	288
2	79 1/2 in	6	576
3	118 1/2 in	9	864
4	157 1/2 in	12	1152

* IDR 3s and 4s available in one-sided, half units ** IDR7s available in a 378-bottle configuration

Modular Extensions Available

Extension kits allow for modular growth of any IDR racking option.

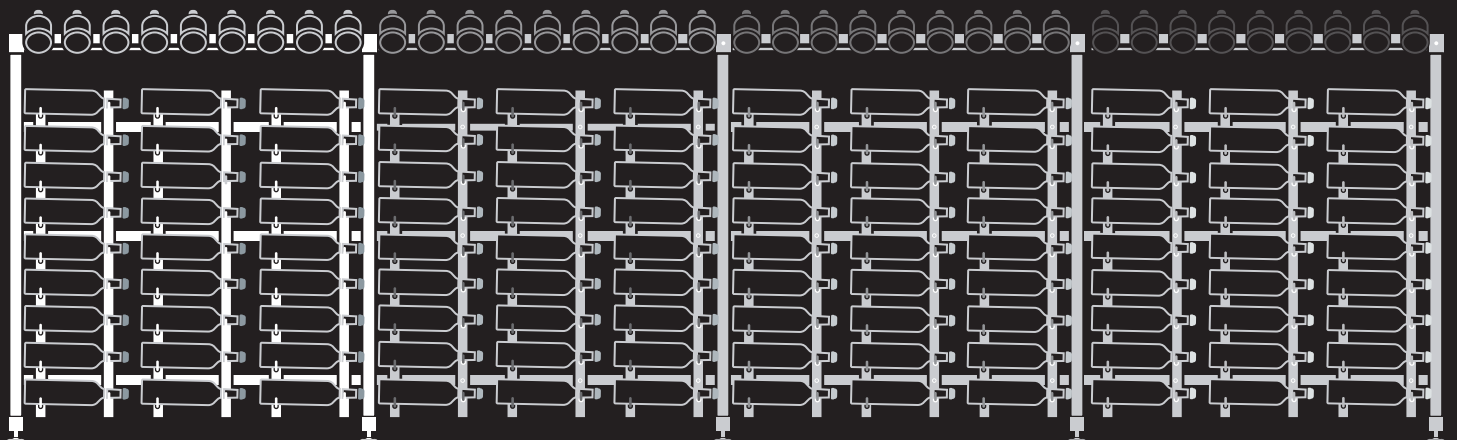

Window Shopping

Wine lovers in New Canaan, CT, explore, by label, the thousands of bottles in the Stewart's Wine & Spirits collection.

It's way better than window shopping.



Highlights
Island Display Racks
IDR Shelf Extension
Satin Black finish
3,267 bottles

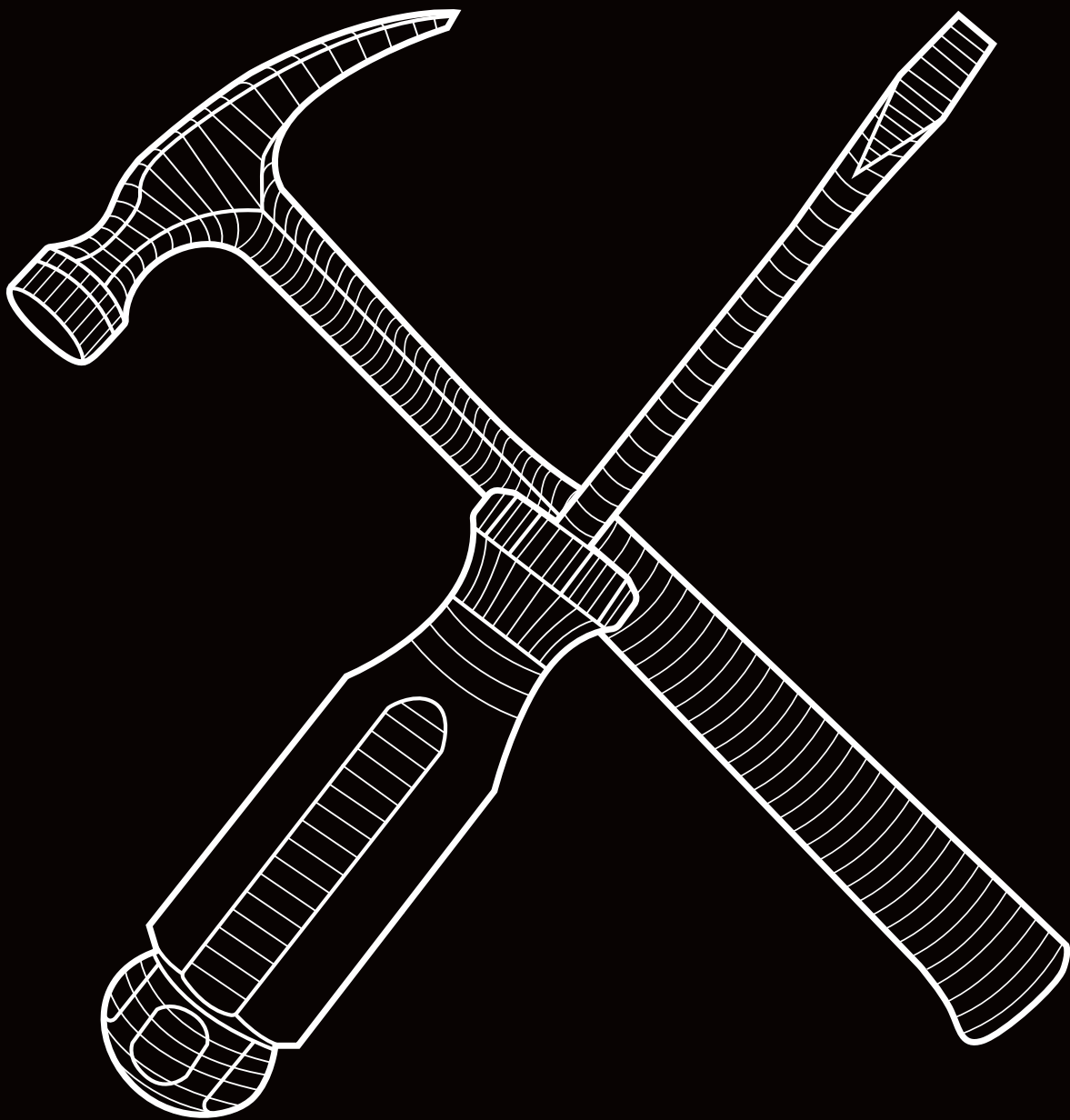

Resources

We create the world's best looking and most trusted metal wine racks.
Since they don't install themselves, we back our products
with industry-leading support.

Custom, 4 Ways

With the designer's touch, our standard wine racking systems configure to fit just about any custom wine cellar space. However, we recognize that some projects — due to room oddity or style request — call for something fabricated from scratch to meet unique needs.

We have you covered. Let's brainstorm. Custom options include:

1. Complete ground up metal fabrication

- Ladder-style support (pictured)
- Diamond Bin Cabinets
- Metal case storage

2. Custom Evolution Panels (acrylic)

- Depth: 1 to 12 bottles deep
- Height: Up to 120" tall
- Configuration: Mix bottle sizes, and more

3. We cut to fit:

- W Series Wine Racks (height)
- Evolution Wine Rods (width)

4. Color It

If it's on the color wheel, we can transform any of our metal products with beautiful, durable custom powder coating.



Highlights:
Terrace Drive | Houston, TX
416-bottle wine cellar
Evolution Wine Rods
Custom "ladder" steel supports
Design: Newberry Architecture
Photo: TK Images



Design Services

Know what you want? Great! We'll make sure it fits in the space. Haven't a clue which racking system should go where? We're masters of design who understand what products will work best for your aesthetic, budget, and spatial needs. VintageView's design department offers:

Complimentary 2D Design

All we need is a few days, accurate measurements, and some direction of the project goals.

3D Design

For larger projects needing a more realistic showcase of the wine cellar, we produce 3D room renderings that can look every bit as crisp as a photo.

Resources

If your company has an in-house designer, we speak CAD and Revit, and we are happy to provide files to use on your systems.



Training & Product

There's no need to head into a client meeting without a full understanding of VintagView products and wine cellar building knowledge.

Cabernet & Credit CEU

We've flipped the classic Lunch and Learn into an engaging 90-minute program hosted at amazing restaurants throughout the country. Our AIA/IDCEC certified course covers **6 Steps to Designing a Modern Wine Cellar** and is served with wine and tasty snacks.

CEU Online

Take our AIA/IDCEC course on your own time through our partnership with AEC Daily. You'll need to provide the wine.

Webinars

From consultation tactics to product knowledge, we provide five unique online courses each quarter. Take them all!

Installation Resources

Our robust video and PDF library will take you through the nuances of installing VintagView with ease.



It's all about the FINISH

Luxe edition

We've elevated our Chrome offering by removing the plastic finishing pieces, rounding the rod tips and plating the mounting hole covers for a final product even more beautiful than before (didn't think that was possible!?!).

Available Feb. 1.

Five Flavors

With the addition of Gunmetal and Golden Bronze, VintageView now offers five unique finish offerings for our designer-focused Vino Series line. The versatility is unmatched in the industry.

Custom colors

We've streamlined the powder coating process, from quoting to fulfillment, meaning we can create a unique color to match the room you are designing.

Need a bronze gloss hammer finish? How about mock rock or gray zinc? If it's on the Cardinal Paint color wheel, we can customize the look of every single VintageView wine rack.



VintageView Product Showcases

Our Design Center is arguably the best place in the US to see a wide range of VintageView products in the context of residential and commercial design. However, we understand Denver, CO, is not a quick drive for everyone. To help, we have partnered with some of the best wine cellar builders and interior design specialists to feature our wine racks in their beautiful showrooms. From Scottsdale to South Florida, and Calgary to upstate New York, there's probably a VintageView showcase nearby.

Want to be a showcase? If you have a showroom and work in a related design/build business, we'd love to talk with you.

Can't find a showcase nearby? There's probably a tasty wine bar or restaurant with our systems on display. Or swing by our Design Center on your way from Denver International Airport to Vail.

VINTAGEVIEW.COM/CATALOG20





Designer's Choice

Since 2015, the Mile High City's top design pros have come together to create the Denver Life Magazine Designer Showhome, a multi-million dollar residence that shows off an impressive blend of aesthetics and livability to hundreds of area design buffs.

The invited tastemakers are each assigned a room and tasked to create something stylish and relevant, featuring the best in furnishings, decors, technology, and more. Naturally, VintageView has been featured each year.

SEE THE CELLARS:

- 2015: 384-bottle wine wall featuring W Series racking. **PAGE 13**
- 2016: 184-bottle wine room featuring W Series and Vino Series racking. **ABOVE**
- 2017: 32-bottle wine display using Vino Rails. **PAGE 25**
- 2018: 270-bottle glass wine box featuring Case & Crate and W Series collections. **PAGE 45**
- 2019: 56-bottle wine feature using Vino Series Rails and Pins. **PAGE 21**



TASTING
BAR



VINTAGEVIEW®
vintageview.com/catalog20